

STMR Mk II

Installation and Operation



Contents

1.0 Overview & key features.....	3
1.1 System Components.....	3
1.2 Performance.....	8
2.0 Installation	10
2.1 Pre-installation Tests.....	10
2.2 Sensor head Installation.....	10
2.3 Control box Installation.....	12
2.4 Accessories & Front Panel Connectors.....	14
2.5 Embedded Software Configuration Files.....	15
3.0 Operation & Testing the Installation.....	17
3.1 Initial power up after installation	18
3.2 Stationary Tests	20
3.3 Mobile Tests.....	21
3.4 Advanced Tests	21
3.5 Maintenance.....	23
4.0 Application Software.....	24
4.1 Installation	24
4.2 Setup.....	25
4.3 Operation	33
4.4 Array Commands	41
4.5 Tools	46
Appendix 1: Front Panel Connectors.....	54
A1.1 Power Switch	54
A1.2 Power Socket.....	54
A1.3 Ethernet	55
A1.4 Road Wheel.....	55
A1.5 GPS.....	56
A1.6 Auxiliary	57
A1.7 Rx Coils	58
A1.8 Tx Coils.....	58
Appendix 2: Data Protocols & Software Specifics.....	59
A2.1 Application Software Installation Files	59
A2.2 GPS Data Frames	59
A2.3 Log File Format.....	60
A2.4 Marking System Protocol.....	61
Appendix 3: Trouble-shooting.....	63
A3.1 Can't Connect STMR Application To The Array.....	63
A3.2 Step changes in the Sensor Data	65
A3.3 Nothing Works	65
A3.4 Front panel LED problems.....	66
A3.5 Noisy Data	66
Appendix 4: STMR Specifications.....	68
Appendix 5: Ordering Numbers	71

1.0 Overview & key features

The Minelab Single Transmit Multiple Receive (STMR) Mark II array is a high performance, sensitive metal detection system designed for vehicle mounted use for large area mine clearance operations. The Minelab STMR Array has a range of features to provide high-resolution location of both ferrous and non-ferrous metal targets: up to 20 detection zones across the sensor head width, logging of GPS location, logging of road distance data from third-party road wheels, and triggering of third-party road marking systems.

The advanced processing abilities of the STMR array allows the user to configure the system for use in a wide range of mineralised soil types and ground speeds. The configurable settings for signal coupling provide enhanced drift tracking and detection depth, while the settings for filtering speed optimise signal response for the chosen vehicle travelling speed.

1.1 System Components

The STMR system is comprised of a sensor head, a control box, and application software. Figure 1.1 below illustrates a typical setup.

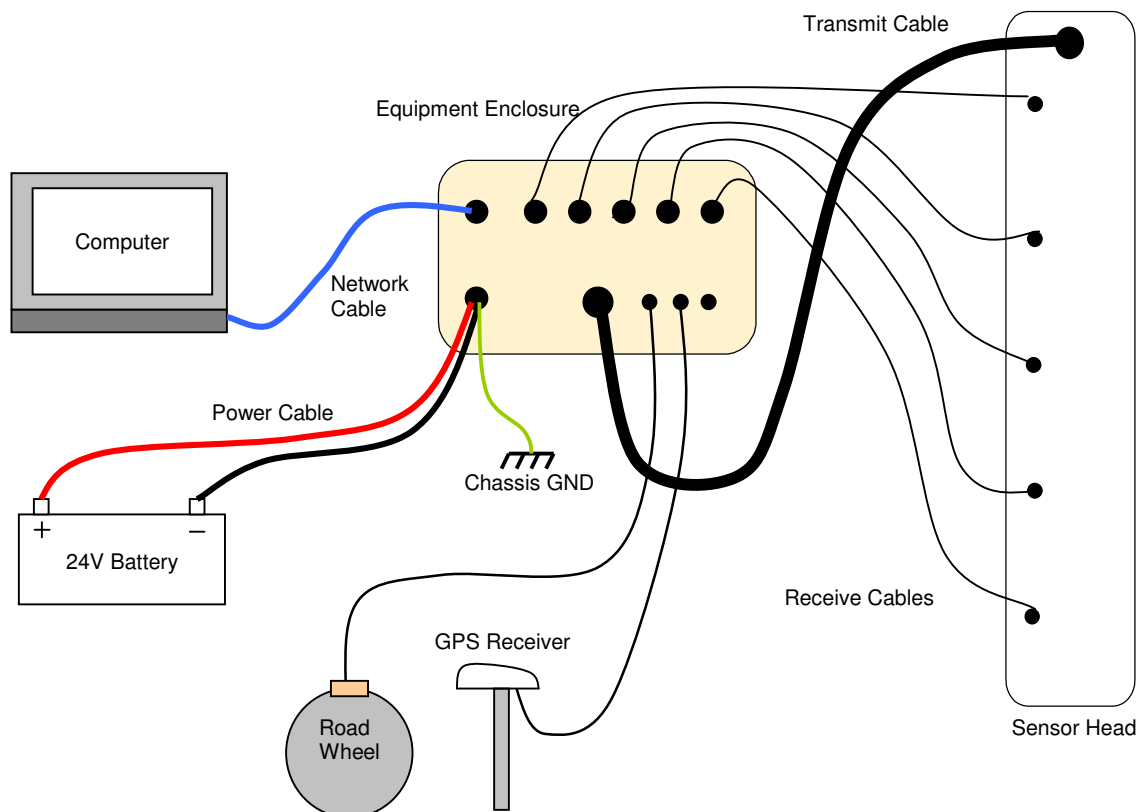

Figure 1.1

1.1.1 The Sensor Head

The Sensor Head contains the following sub-components

Transmit (Tx) winding: Large coil wound around the outer edge of the sensor head assembly for radiating EM energy into the ground.

Receive (Rx) windings: There are two types of Sensor Head, each containing different configurations of Rx windings. Depending upon the specification of each particular system, the Sensor Head can contain Monoloop (ML) windings only (figure 1.2a), or pairs of a ML and a Figure '8' (F8) winding (figure 1.2b).

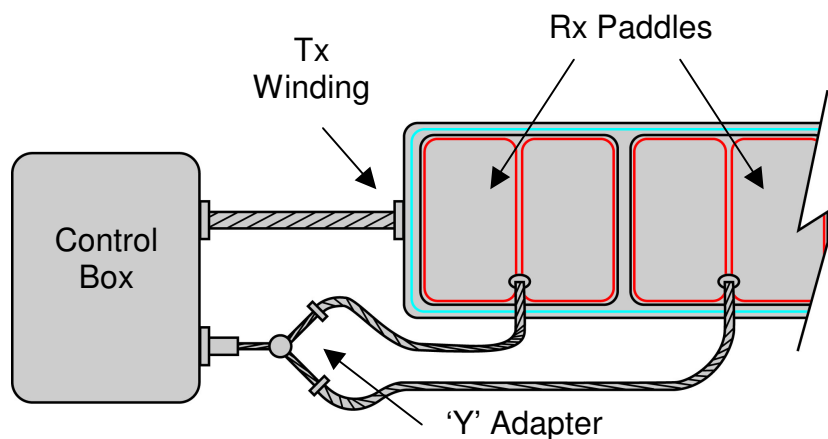

Figure 1.2a: Standard configuration, ML Sensor Head

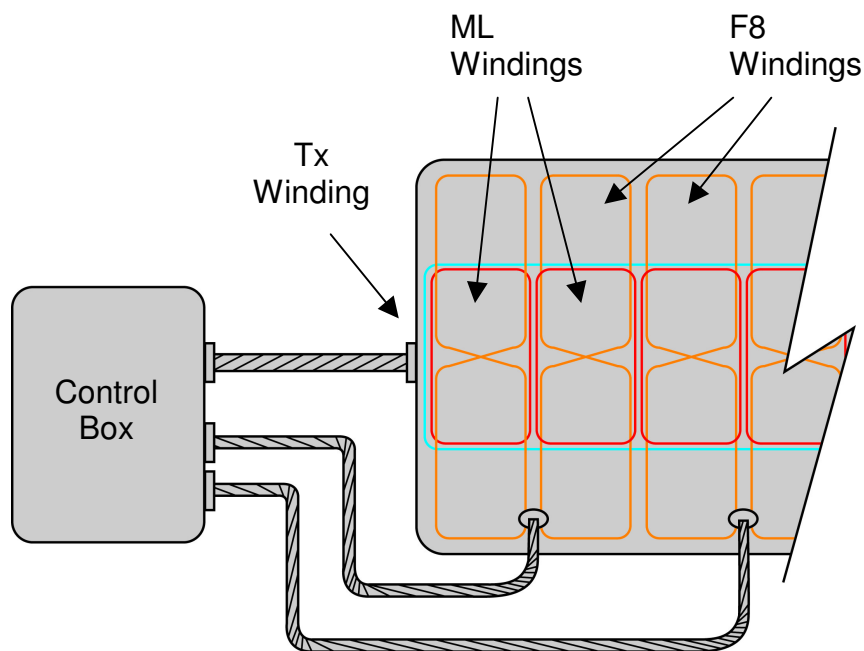

Figure 1.2b: Optional configuration, ML/F8 Sensor Head

- The ML windings receive signals from the eddy currents in conductive targets between active pulses of the Tx.
- The F8 windings can receive signals, mainly from the instantaneous magnetisation of targets, during the Tx pulses, allowing some assessment of the ferrous properties of targets. They are positioned in such a way that they receive no net signal directly from the Tx.
- F8 windings can also receive signals between pulses, just as the ML windings do.
- If your Sensor Head includes only MLs, each Rx cable is connected to two MLs.
- If your Sensor Head includes ML/F8 pairs, each Rx cable is connected to two pairs of a ML and a F8. The windings of a pair are positioned one directly above each other.
- Sensor Heads with only ML Rx windings come with the Rx windings housed in 'paddles' that are separate from its main part containing the Tx winding.
- Sensor Heads with ML/F8 Rx pairs come as one piece; this type of system is sensitive to relative movement of the windings, thus require all to be fixed in position relative to the Tx.

1.1.2 The Control Box

The Control box contains three main sections which are referred to by their location within the enclosure: The lower assembly, the upper assembly and the front panel.

The Lower Assembly (figure 1.3) contains the power supply and transmit sections of the system and connects to the Tx winding. Forming this assembly are four main PCBs that that are fastened to the lower steel frame...

- **Power Supply:** Raw 24V from the vehicle supplied to the control box is filtered and transformed into all the necessary power rails used throughout the unit.
- **PS Micro:** This board generates all the timing signals used by the lower assembly set of boards. The primary job of this board is to control the transmitter and to ensure the Tx signal is synchronised to the Sensor cards in the upper assembly.
- **Transmitter:** The generation of the high voltage / high current transmit waveform is a complex task and is performed by this board.
- **Recovery:** Generating the transmit waveform inherently produces high voltages on the transmit winding. The Recovery board regulates and recovers this high voltage energy and returns it to the power supply board.

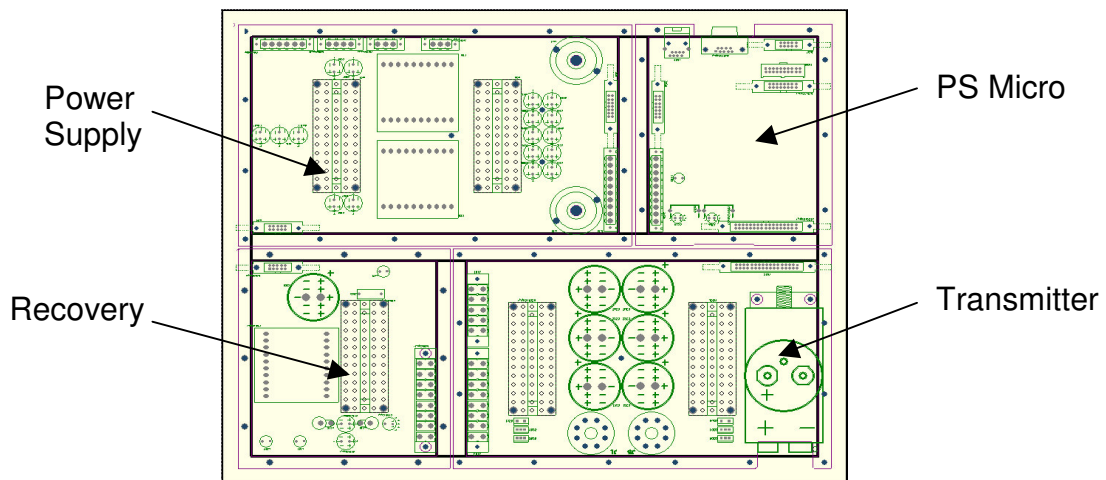

Figure 1.3

The Upper (Rack) Assembly (figure 1.4) contains the Controller and Sensor (Rx) cards, and connects to each of the Rx windings. There are up to thirteen PCBs that form this section...

- **Sensor Cards:** Each system contains between four and ten sensor cards. These contain the sensitive receive electronics that detect the variations in the magnetic field generated by the transmitter, due to the presence of metallic targets.
- **Controller:** In order to ensure each Sensor is perfectly synchronised to every other Sensor, a single set of timing signals is generated by this card. It also collects the output signals from each Sensor card and combines them all into one data stream before communicating it to the host computer.
- **Backplane:** The upper assembly of cards utilises a standard DIN rack card methodology to connect all cards together. Each card plugs into the backplane which provides data, analogue signals and power to all upper assembly boards
- **Ethernet Repeater:** Due to the large volume of data generated by the sensor cards, the industry standard Ethernet style communications system was adopted to ensure reliable and robust data transfer. The data from each sensor card, and the PS Micro, is combined and fed to the Controller card through this board.

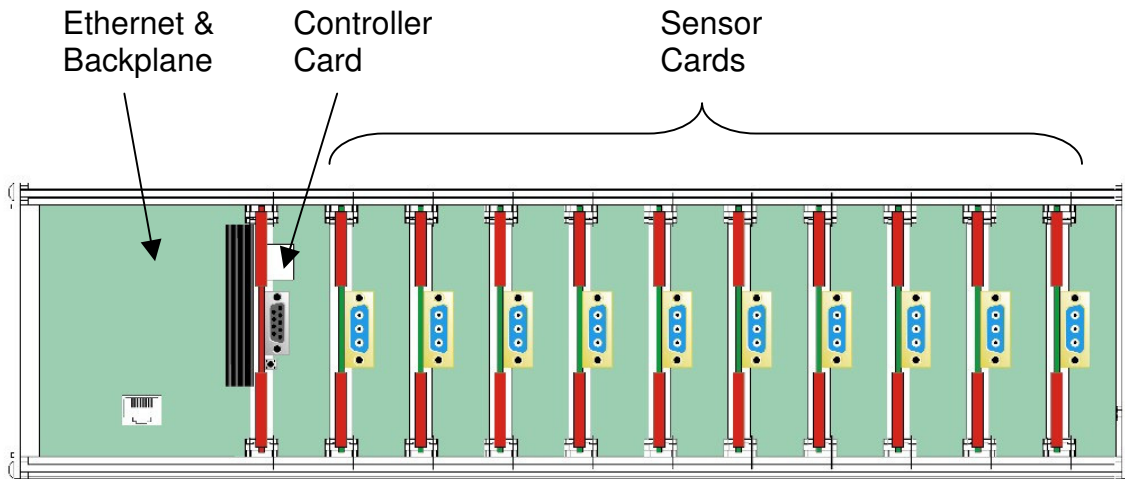

Figure 1.4

The Front Panel (figure 1.5) is used to mount all the sockets and to indicate system status to the user by a series of LEDs. These LEDs, along with the Rx signals from the Receive coils, are connected to the rest of the system via a PCB mounted to the rear of this panel.

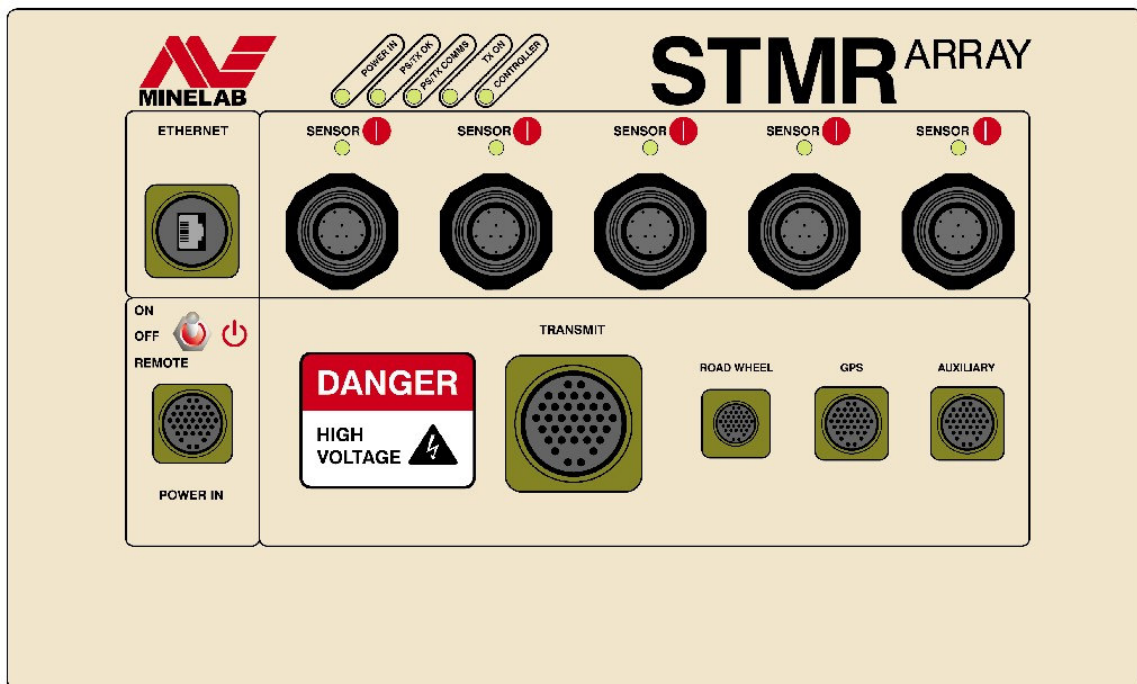

Figure 1.5

1.2 Performance

The STMR system can detect a wide range of metallic targets buried in un-mineralised ground through to highly mineralised ground. When the hardware is used in conjunction with the provided application software, a high-performance, fully-featured detection system is realised. Some of the key features are...

- Location of targets to within an area of 20x20cm.
- Logging of target detection signals to files in conjunction with coincident GPS coordinates, time of detection and distance travelled data.
- Real-time display of each Rx coil data stream using intuitive coloured charts
- Software selectable target thresholds for triggering external road-marking systems.
- Built in ground noise reduction allows detection of small targets in mineralised ground.
- Coupling of output data, through selectable filters, to optimise tracking of gradual changes in Rx signal output.
- Discrimination between ferrous targets and non-ferrous targets, using the X-channel data from the Figure '8' windings, can be useful in rejection of signals from clutter.
- Determination of the depths of targets can be achieved using the Target-channel data from Figure '8' and Monoloop pairs along with simple gradiometric analysis.
- Orientations of familiar targets can be determined using the Target-channel data from adjacent Figure '8' coils.

1.2.1 Safety

In order to achieve the outstanding performance of the STMR array system, dangerous high voltages up to 475V are generated inside the control box and are present in the Transmit coil and cable during operation. Minelab recommends that the system only ever be operated with the control box closed and that all cables be inspected regularly for wear and general condition. If the control box must be opened, for instance to upgrade internal software, ensure the system has been left switched off with the power disconnected for at least two minutes to ensure sufficient time for internal voltages to discharge. If damage to the transmit coil or cables occurs, replace or repair immediately in accordance with Minelab instructions.

When operational, the STMR array system generates strong electro-magnetic fields around the sensor head. Minelab recommends caution for persons approaching the sensor head as the human body, and in particular medical equipment and implants such as pacemakers, may be susceptible to these strong fields. Credit cards in the wallets of users can also be adversely affected.

Only ever connect or disconnect the transmit winding cable when the system is switched off. Failure to observe this requirement could result in damage to the equipment or injury to persons.

Never operate the STMR system with the sensor head in very close proximity to large metal objects, such as placing the sensor head on the bonnet of a truck. Operation in this manner could result in large power supply currents and possible activation of internal safety circuits.

1.2.2 Application software

The STMR Array hardware can work in conjunction with custom written software or with the Minelab application software provided for development purposes. The software provided with the array allows access and control of all functions and will display real-time and recorded data. Key features are...

- Display real time data output from the STMR array in any of three different styles: coloured vertical streaming bar chart (waterfall), 2D horizontal line chart, and relief style pseudo 3D chart snapshot styles.
- Logging of real-time data to file for later detailed analysis.
- Logging of target detections with coincident GPS, time-of-day and ground distance travelled data.
- Retrieval and on-screen display of logged data.
- Activation of external road marking systems via industry standard RS232 port.
- Retrieval, editing and saving of embedded configuration files. These files hold the hardware settings such as filter speeds and types.
- Setting of all array parameters such as number of sensor coils, type of coils, connected GPS or road wheels, etc.

The Minelab application software will operate on any standard Windows 2000 / XP based platform. Log files can be stored in comma or tab-delimited ASCII XML files.

1.2.3 Environment

Harsh conditions are a normal part of life for counter mine operations. The STMR Array has been designed to work reliably under these conditions for many years with minimal service requirements. The system will continue to work reliably in arctic conditions through to heavy tropical rain storms. The Military Specification Control box enclosure includes internal vibration isolation to absorb transport shocks and knocks, while all cables lock securely to their mating receptacles for trouble-free operation during deployment.

2.0 Installation

As the STMR Array is a large vehicle-mounted system and can be supplied with various options, it is shipped in more than one box. Before installation, each box should be opened and the contents checked for completeness and the presence of any shipping damage.

Once all system components have been inspected, they can be installed onto the vehicle. There are many ways in which the system can be configured and mounted, so specific installation instructions are not given in this manual. Instead, each major component is discussed and considerations listed for the user to determine a mounting system that best suits individual needs.

2.1 Pre-installation Tests

As the STMR system is a high sensitivity metal detector, careful consideration needs to be given to system layout and component location. Proximity of metal objects in the mounting system, or the vehicle itself, could affect performance, as can electrical or electronic devices such as computers, alternators, and radios. Prior to permanent installation, Minelab recommends that the user read the remainder of section 2 of this manual, then temporarily install all system components before conducting some basic system testing, as described in sections 3.0 to 3.2. This will help ensure the system will work to optimal levels.

2.2 Sensor head Installation

There are two varieties of Sensor Head (refer to “1.1.1 The Sensor Head”):

- Sensor Head with integral Tx winding and removable Rx paddles; or a reel of special Tx wire for custom sensor head manufacturing along with a set of Rx paddles. This is referred to as a ‘Mono’ sensor head.
- Sensor Head with one solid component containing both Tx and Rx windings. This is the option to select if Figure ‘8’ windings are required, and is referred to as a ‘Mono/Fig 8’ or ‘Clutter Rejection’ sensor head.

If the custom option has been specified, the custom sensor head should be constructed up to and including the winding of the Tx coil before completing pre-installation tests. Please refer to specific Minelab instructions in this instance.

Once the Sensor head is unpacked, determine how the assembly will be mounted in its intended operating position on the vehicle. There are various options and these are outlined below...

- **Supported-push:** The sensor head is suspended from booms mounted to the front of the vehicle.
- **Supported-pull:** The sensor head is suspended from booms mounted to the rear of the vehicle.
- **Dragged-push:** A custom wound Tx coil (required to conform to the contours of the ground), combined with Rx paddles, is placed on top of a wear-resistant mat or tray that is simply dragged along the ground using ropes connected to beams mounted to the front of the vehicle. Alternatively, the standard Sensor Head is placed in a tray with non-metallic wheels that support the assembly just above the ground. In either case, contact with the ground is intended.
- **Dragged-pull:** Similar to above, except where the custom sensor head is dragged behind the vehicle.

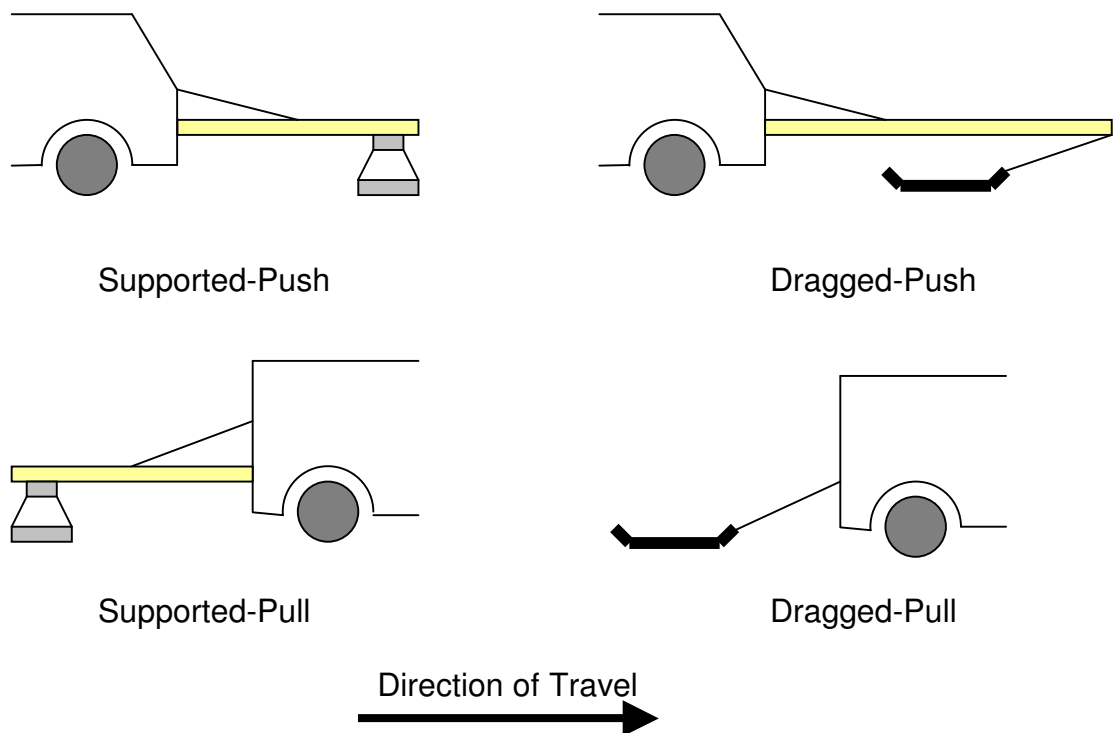

Figure 2.1

Whichever method is chosen, there are some common issues to be considered to ensure noise and sensing depth are not adversely affected...

- Proximity of the sensor head to the vehicle can affect the performance in two ways.
 - There will always be some movement between the vehicle and the sensor head due to the mounting system. These relative movements will produce significant 'noise' in the target signals that will get worse the closer the sensor head is to the vehicle or the greater the movement.

- Metal objects that are stationary with respect to the sensor head produce a DC shift in Rx channel response which can often be nulled out when the 'Adjust Zero' button is pressed. However, the proximity of large metal objects can reduce the overall target detection range by shifting the 'zero' position towards one of the limits of detection range. The more metal, the less detection range. Minelab recommends mounting the sensor head at least 1.5m from the vehicle.
- Proximity of metal fasteners to the sensor head can have similar effects to those described above. Reduced detection range and noise induced by vibration can diminish performance. Minelab recommends the use of non-metallic fasteners near the sensor head. If this is not possible, use of non-magnetic stainless steel usually proves satisfactory.
- Sensor Head with Rx paddles can be operated with the paddles simply sitting in place, but for normal use or transport, Minelab recommend fitting the retaining straps and screws to prevent the paddles jumping out of position.
- Mounting of Tx and Rx cables can affect performance. Always run cables away from the sensor head and onto the mounting booms in as short a distance as possible and do not run cables directly over coil surfaces. Cables contain metal and movement of them relative to the coils can cause false target signals, despite special design techniques being employed to minimise these effects.
- It is best to separate the Tx cable from the Rx cables, so for example run the Tx cable along one support beam and the Rx cables along another. This helps to minimise noise in the Rx data.

In addition to the considerations above, general wear can be reduced and service life extended by adhering to the following...

- All cables can suffer fatigue if continually flexed. Tx and Rx cables should be securely fastened to the Sensor Head booms if these are used to minimise flexing induced by vibration. Be careful not to secure too tightly or with sharp bends, as this could damage the cables.
- The sensor head is NOT designed to be dragged directly on the ground. If a 'drag' method is to be used, a separate assembly or drag mat should be utilised to protect the sensor head.
- The sensor head is designed to be resistant to rain, but only with cables connected or the water-proof caps fitted. Do not leave the sensor head outdoors without the cables or protective caps fitted.
- When mounting the sensor head to the support frame, do not over-tighten fasteners, as this can damage to the structure.

2.3 Control box Installation

The control box comes pre-assembled except for the optionally fitted sun shields which may be packaged separately. Unpack the control box and place it in its intended operational location. If this is outside the vehicle and no shielding from direct sunlight is provided, ensure the sun shields are fitted. Choose the location for the control box after considering the following...

- The control box is rain-resistant when all cables or socket covers are fitted, or the control box lid is closed. Do not expose the control box otherwise, as ingress of water could occur.
- The control box dissipates around 100W of power in the form of heat. It is important to ensure good airflow around the top and side surfaces at all times.
- Whether or not the sun-shields are fitted, ensure at least 50mm of clearance around all surfaces is provided to allow for clear airflow around the enclosure for cooling.
- If the system is to be operated in extremely hot conditions (above 40°C), service life will be extended if the control box is located within the cabin of the vehicle, as this will reduce internal temperatures.
- The control box electronics is supported by internal shock mounts to reduce the effect of vibration. This does not make it shock 'proof', so ensure it is securely fastened to the chassis or other rigid support member of the vehicle so it does not bounce.
- The control box should be mounted upright, or it can be mounted on its back if protected from rain. The mounting points for the sun shields are not intended to be used for securing the control box. Minelab suggest using straps or clips around the box or handles to secure it, and never to install the control box in any other orientation than as specified above.
- The metal surfaces of the control box enclosure should not make electrical contact with the chassis of the vehicle (for instance by installing screws through the enclosure walls or scratching through the paint), as this can produce noise in the Rx data. The power connector contains a pin specifically for connection to the vehicle chassis as described in section 2.3.1.

Once the control box is installed, the sensor head can be connected. Remove the front panel cover and connect each of the Rx cables to the front panel. If a 'Monoloop' Sensor Head is supplied, connect the Rx cables using the 'Y' connectors provided. Each 'Y' connector joins two Rx paddles to one front panel socket. If a 'Clutter Rejection' Sensor Head is supplied, simply connect the five Rx cables between the Sensor Head and the front panel sockets directly.

Next, connect the Tx cable by firstly aligning the groove and guide, then gently wiggling the plug whilst turning the retaining nut clockwise until the plug can no longer be wiggled. Tighten only by hand to avoid damage.

For all of the Tx and Rx cables, ensure the control box ends have sufficient extra length so none are pulled tight. Loosely curl excess cable length near the control box, but DO NOT cut or shorten the cables as this will degrade performance. The Tx cable is supplied with either a straight or right-angle connector. Ensure this is not under strain when connected to the front panel.

2.3.1 Control Box Power Connections

The control box utilises two main ground systems: one for the 24V battery supply, and another for the internal electronic circuits and chassis ground. Installation of the electrical connections is a straight forward process so long as the following points are adhered to...

- The front panel connectors share the ground connection with the control box chassis, except for the Power Input connection which is isolated. Refer to the appendix for details of the socket pin connections.
- Run a red wire from the front panel Power connector +24V pin, through a fuse or circuit breaker of 10A, to the +24V vehicle battery terminal or separate power supply.
- Run a black wire from the front Power panel connector 0V pin, through to the vehicle negative battery terminal or separate power supply. Do not connect directly to the vehicle chassis near the control box.
- Connect a green wire from the front panel Power connector GND pin to the vehicle chassis, as close as possible to the control box. This wire ensures a reliable connection so current does not flow through the mounting system.
- The remaining pins in the Power connectors are for a remote on-off switch. Refer to section 2.4 for details.

This technique ensures a clean supply of power to the system, and a solid ground connection to the chassis. This helps to minimise noise and reduces susceptibility to other electrical equipment. If the STMR system is mounted in a trailer or other towed vehicle without its own power source, use the same method as described above but also ensure a solid electrical connection between the trailer chassis and the vehicle chassis. The tow hitch itself is usually insufficient for this purpose and a separate Ground-wire connection should be implemented.

2.4 Accessories & Front Panel Connectors

Once the Control box and Sensor Head have been installed, external third-party devices can now be connected, depending upon the particular system installation requirements.

Appendix A1 provides pin connections details for all front panel connectors so that users can make custom connections as required. Each socket has a specific purpose with various signals provided to the user for control and monitoring of the array. These are described below...

- **Power:** As described in the previous section, this socket provides raw 24V power to the system from the vehicle supply. It also contains pins for connection of a low-current remote switch which can be located elsewhere in the vehicle to allow power up and down of the array when the front panel switch is placed in the 'Remote' position. Placing the front panel switch in the 'On' position bypasses the remote switch and powers up the STMR array.

- **Ethernet:** Connect the Control Box to the host computer using a standard RJ45 Ethernet cable, with the supplied water-proof cover fitted if the control box is to be located outside the vehicle cabin. The connections are internally isolated through a transformer, so are independent of ground.
- **AUX:** This socket includes auxiliary RS232 communications, Shutdown, a HV monitoring line, and a second set of low current remote power switch connections. +6V is also supplied. These connections are referenced to the common chassis ground. The RS232 communications allow monitoring of the PS Micro status (system integration and debug use only); the Shutdown pins allow connection to a momentary push-button to initiate a controlled shutdown of the transmitter; the HV monitoring line provides a voltage that is 0.01 times the internal 475V rail, so that under normal conditions 4.75V will indicate 475V internally (again, system integration or debug use only).
- **GPS:** Connect an appropriately configured external RS232 or RS485 (factory configured) GPS receiver to this socket. +6V is available and is referenced to the common control box chassis ground.
- **Road Wheel:** A third-party road wheel rotary encoder can be connected to this socket for measuring travelled road distance. +6V is available and is referenced to the common chassis ground.

2.5 Embedded Software Configuration Files

The STMR control box contains three embedded configuration files that store various parameters and settings for control of the system. These files can be accessed through the Ethernet connection by using the supplied application software, so please refer to section 4.5.2 for details of how to modify these files.

The three configuration files are read by the STMR array electronics only at power-up, so if changes are made by the user, the system must be powered down then restarted to implement them. Each of the files is heavily commented to assist the user with making modifications as required. As shipped, however, the files should be suitable for all normal operations and should not need modification, other than to set a new IP address to match the local network to which the STMR array will be connected.

The three files are described below. Refer to section 4.5.2 for further details.

2.5.1 Ethernet.conf

This file contains the static IP address of the STMR array system – dynamic addressing is not supported. A typical example of this file is given in section 4.5.2.1

The four lines in the file that are acted upon by the software are the MAC ID, the IP Address for the unit, the Net Mask and the Broadcast IP Address.

Normally, only the IP address and the Net Mask will need to be changed by the user. The default IP address, to which the system reverts if the file becomes corrupted, is 192.168.10.180. When shipped from the factory, a different IP address may have been assigned, but if so this will be clearly marked on a tag hanging from the front panel, or in other shipping documentation. If the IP address is not known and the unit does not respond to the suggested IP addresses, contact Minelab.

Note: Each STMR Array is assigned a unique MAC ID at the factory. This number should not be changed.

2.5.2 Sensorctrl.conf

Parameters for the Sensors cards and the Power supply are stored in this file. A typical example is given in section 4.5.2.2

2.5.3 Debug.conf

The IP address of the debug server is contained in this file. The debug server echoes debug statements from the controller to the specified IP address, in a similar manner to the RS232 data available from the front panel AUX connector for the PS Micro board. Minelab recommend not using this facility unless a debug terminal is active as startup times will be extended. An example is given in section 4.5.2.3

3.0 Operation & Testing the Installation

Virtually all of the STMR Array functionality is accessible from a computer via the Ethernet connection so is described in detail in section 4, 'Application Software'. The front panel of the system however displays some important information that can be used during initial testing and installation.

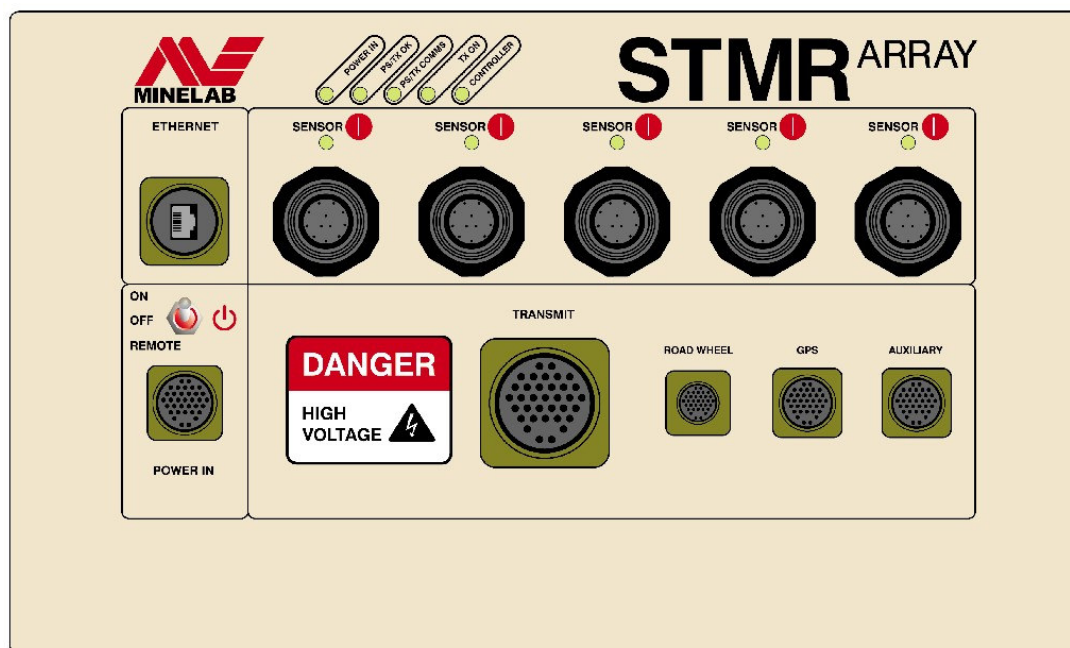

Figure 3.1

Status of the power supply, transmitter and Controller are indicated by the five LEDs at the top of the front panel...

- **Power In:** Indicates raw 24V power from the vehicle is present and the front panel or remote switch is 'On'. If the LED is blinking this indicates a vehicle 24V supply problem or an internal power supply fault.
- **PS/Tx OK:** When the first power supply stage is fully operational and the PS Micro has booted up successfully, this LED will light.
- **PS/Tx Comms:** The PS Micro communicates with the Controller card, so when communication is established and both PCBs are operational, this LED will light
- **Tx On:** This LED will light when the Controller card takes control of the system timing and switches the transmitter on. The transmitter is powered up in a number of steps - this LED indicates all of these steps have been completed, the Tx is running at full power and that the system is ready for use.

- **Controller:** Once the Controller card has powered up and has established communications with the Ethernet backplane, sensor cards and PS Micro, this LED will light to indicate normal operation. A Blinking LED will indicate a fault, such as an internal communications problem.

In addition to the five system status LEDs are the five Sensor Card LEDs. Each of these indicates the operational condition of two sensor cards, so that for instance the LED marked 'Sensor 1|2' will light when both sensor card 1 and 2 have powered up and are successfully communicating with the Controller. If one of the two cards fails to power up correctly, the LED will blink. If both cards associated with the LED fail to power up, or are simply not present, the LED will stay dark.

3.1 Initial power up after installation

Before and after installation of the STMR array system, some basic tests should be conducted to ensure each system component is located appropriately and that performance will not be affected by nearby metal objects or electrical noise from other devices. By following each of the following sections of this chapter, the installation can be checked at various stages to ensure optimal performance has been achieved.

Before powering up the array, the provided Minelab STMR application software must be installed and the control box settings initialised so please refer to section 4.1 for instructions.

Once the software is installed, move the vehicle into a clear section of ground away from metal objects, power lines, underground water pipes and other objects that may cause disturbance. Power up the computer, start the application software and then follow the steps below to establish a connection

- Ensure the Tx connector is disconnected from the front panel.
- Move the STMR front panel power switch to the 'ON' position.
- Ensure the 'POWER IN' LED lights up, followed after a short time by the 'PSTx OK', 'CONTROLLER' and the 'PSTx COMMS' LEDs. The 'Tx LED' should stay off.
- In the application software, select the 'Array Setup' tab.
- Click the 'Change...' button in the Array IP address box and type in the IP address as indicated on a tag attached to the front panel, or in the shipping documentation. If the address can not be found, try the default address of '192.168.10.180'. Refer to Appendix A3.1 for connection details.
- In the Number of Coils box, select the number of Rx coils connected to the STMR control box. Note: one paddle equals two coils.
- Before attempting to establish an Ethernet connection, allow 30 seconds for embedded array software to boot up after power on. Click the top left button marked 'Connect' to connect with the Array system. The message 'Connected' should appear in green text in the status bar at the bottom of the window and a pulsing heart shaped icon should appear in the bottom status

bar. If connection is not established please refer to the trouble shooting section in appendix 3.

- The communication system passes the preliminary test once a connection has been established. Now click on the 'Shutdown' icon then switch off the control box power switch and ensure all LEDs go dark.
- Connect the Tx cable by aligning the polarity marks of the plug and socket and then push gently whilst turning the retaining nut clockwise. Keep gently pushing and wiggling the plug and turning the retaining nut until the plug no longer wobbles and the nut begins to tighten – do not use a tool to tighten.
- Switch the control box power switch back on.
- The 'POWER IN' followed by the 'PSTx OK', 'CONTROLLER' and the 'PSTx COMMS' LEDs should come on. After about a minute the 'Tx ON' LED should also light. This indicates the system is fully operational.
- In the application software click the 'Connect' button to re-establish a connection.
- Once a connection is established, click the 'Enable Data' button and scrolling of Rx channel data should begin on screen. Note: Rx data is only available when the 'Tx On' LED is lit.
- Click the 'Adjust Zero' button after ten seconds and all Rx coil traces should become green. This indicates each channel has been adjusted to zero.
- Open the 2D chart window and enable all traces. All traces should now display noise.

Now that a valid connection has been made, the user should issue some default commands to the STMR array control box to ensure a standard configuration for testing. Refer to section 4.4 for details on how to issue commands to the control box.

- Filter: Medium
- GB Mode: None
- Sampling Rate: 100Hz
- Receive Timings: 0 (for standard mono loop only coil)
- Receive Timings: 3 (for figure '8' / mono sensor head)
- Press 'F4' to zero Rx data outputs again.

The STMR array system is now fully operational and ready for testing. When viewing signal data on the 2D chart, it is normal for some or all of the Rx data traces to fluctuate slightly as this indicates low level background noise. However, an amplitude exceeding approximately ± 100 counts indicates an excessive noise problem that should be rectified before pre-installation tests can be completed. Refer to Appendix 3 for suggestions on noise minimisation.

3.2 Stationary Tests

The first round of testing is intended to check the ability of the Sensor head to detect the vehicle body and electrical accessories, and to confirm correct operation.

- With the vehicle stationary, the engine switched off and the sensor head raised around 0.5 to 1m above the ground, gently shake the sensor head up and down slightly then in all directions. Any detectable metal objects will show up as target responses or excessive noise on screen.
- The sensor head mounting frame components should also be checked for metal content by holding the sensor head steady (by placing on cardboard boxes for example) then moving each of the beams, cross members and fasteners with respect to the sensor head. Any detectable metal objects will again show up as target responses or excessive noise on screen.
- Start the vehicle engine but leave the vehicle and sensor head stationary. Running the engine at different speeds, check whether engine noise causes interference before switching on and operating each vehicle accessory in turn such as radios, computers, windscreen wipers and cooling fans.

If any of the above tests result in displayed responses, that are significant compared to the smallest signals that will be encountered during the intended use of the STMR, the cause should be identified and corrected. The sensor head might have to be moved further from the vehicle body, cables re-routed, electrical equipment filtered or not operated, or the control box re-located as necessary.

Note: The level of background noise and the level of response caused by the installation that is deemed 'acceptable' depend largely on the intended use of the system and must be determined by the user. If, for instance, the STMR system is to be used for detecting large shallow targets that produce very large target responses, higher levels of background noise and installation-induced response can be tolerated.

Once installation methods have been optimised, the response of the STMR system to a test target should be confirmed by carrying out the following tests...

- Ensure the person conducting the target tests does not have metallic objects on their person such as coins, watches or belt buckles.
- Select a suitable test target, such as a coin or one indicative of the type the system will be used to find when in field use.
- With the sensor head still supported around 0.5 to 1m above the ground and the system operational and displaying scrolling data on the host computer screen, run the test target across the sensor head surface starting from the Tx cable end.
- Confirm that each of the Rx sensor coils detects the target in the correct order, thus showing the progression of the target from one end to the other on screen.
- Next, sit a spacer of approx 100mm height, like a length of timber, on top of the sensor head. This spacer will be used to support the test target at a

constant distance above the sensor head when run from end to end and should be located along the centre line of the sensor head.

- Run the test target along the spacer at a constant speed and continue beyond the end of the coil for a short distance.
- Confirm each of the Rx sensor responses is similar in amplitude, with the end coils generally producing a slightly larger signal than the middle coils.
- If the system is fitted with Figure '8' windings, their associated X-channels will respond to a ferrous target which should be run along the sensor head. Each X-channel should show a signal. A non-ferrous target used in the same way should produce little, or no, signal in the X-channels.

This completes the pre-installation tests. Further testing of the STMR system can proceed once final installation has been complete.

3.3 Mobile Tests

Upon satisfactory testing and completion of permanent installation, driving the vehicle slowly over a short distance is required to check for general movement, vibration and operational effects.

- Start by setting the sensor head around 0.5 to 1m above the ground.
- Drive slowly around a test track while checking for displayed noise. Continuous excess noise or false target signals are likely due to motion while occasional single large target signals in all coils could be due to intermittent operation of vehicle accessories, external influences such as nearby weather radar installations, or large metallic objects that the vehicle passes near the test track.
- Next, stop the vehicle and lower the sensor head to the intended operational height. Minelab recommends a height of around 50mm on flat surfaces and more as required to clear obstacles on uneven surfaces.
- Place some metal objects such as drink or food cans, metal tools and coins at various locations in small hollows in the ground, at least a few metres apart. Ensure the sensor head will clear these objects.
- Drive the vehicle around the test track and pass over the metal objects to confirm strong target responses are displayed. If X-channels are available, confirm that they show strong signals over ferrous targets, but weak signals over non-ferrous targets.
- Bring the vehicle to a stop and continue to watch the real time data on screen to check for noise. After 5 minutes, the background noise should continue to be within allowable limits.

3.4 Advanced Tests

Testing of external third-party devices and their operation with the STMR array system largely depend on individual circumstances. There are however some basic tests that can be conducted to determine whether connections and communications are correct.

3.4.1 Road Wheel

The STMR Array system is designed to support a 90 deg phase lag type digital quadrature rotary encoder based road wheel. There are two pairs of RS485 connections available in the front panel mounted Road Wheel / Position socket: Pos A +/- pair, Pos B +/- pair. Power is also available: +6V and GND, limited to approximately 200mA. Refer to Appendix A1.4 for connection details.

Once the wheel has been connected, the most suitable way to test the device is to start the STMR array and the Minelab application software. By referring to section 4.2.2, following the calibration procedure to check that direction and ticks-per-metre are correctly interpreted and utilised.

3.4.2 GPS

Connection of a GPS unit adds the facility to store location data in the log files. From the factory, the STMR system is configured for an RS485 enabled GPS. Connection details for the front panel mounted '**GPS**' socket can be found in Appendix A1.5 which include GPSTx, GPSRx and GPPS. Power is again available: +6V and GND, limited to approximately 200mA.

Testing is again best achieved through using the supplied Minelab application software. Refer to section 4.2.3 for details of how to configure the software to utilise GPS connection. Once setup is complete, the text box located within the GPS setup Tab will display recent GPS information. To confirm correct location details, simply move the array over a short distance whilst watching the on screen display. Refer to section 4.2.3 for further details.

3.4.3 Shutdown

Before powering down the STMR array, an orderly shutdown of the transmitter and power supplies should be completed. This shutdown can be requested by issuing the '**Shutdown**' command from the Minelab application software or, alternatively, by momentarily pressing a push button switch connected to the '**TxOff**' and '**SigGnd**' pins of the Auxiliary socket on the front panel.

The Shutdown command turns the transmitter off gracefully in stages and stops some of the internal power supplies. After issuing this command the '**Tx On**' LED should extinguish immediately. After a further 10 seconds, the STMR array can be powered down by switching the Power, or Remote, switch to 'Off'.

The STMR array contains various protection circuits to ensure safe shutdown of the transmitter in the advent that power is lost or switched off, but these circuits are intended for unexpected or emergency shutdown only.

3.4.4 Remote Power On

When the '**Power**' switch is in the 'Remote' position the STMR array can be powered on by shorting the '**Rem0V**' and '**RemOn**' pins together. Connect these two pins only to a voltage free switch or relay contacts - do not connect to any power source, battery or other device. Note that these two pins are duplicated in the Auxiliary connector.

Use of the remote power connections allows installation of a switch, for instance inside the vehicle cabin, so that the system can be remotely powered up and down. With the transmitter running, a '**Shutdown**' command should still be issued before powering down the STMR array using a remote switch.

3.5 Maintenance

Very little maintenance is required to operate the STMR array. It is recommended that the following checks be made periodically.

- Check all connectors for dust, dirt, etc, and clean them as required.
- Ensure that the Transmitter Cable connector is firmly seated.
- Ensure that there has been no metallic debris collected in the Sensor Head.
- Ensure the four front panel retaining screws are tight.
- Unused front panel connectors should have their mating caps installed to prevent ingress of water or dust. This particularly applies to unused Rx coil sockets.

4.0 Application Software

The Minelab STMR application software provided with every Array system is a powerful, fully featured tool that allows access to all array functions. The user has choice of three different target signal display modes, and can save and recall target data as desired. In this section, descriptions of how to access and set the parameters is given, whilst for detailed information on the function of some parameters and controls, please refer to the appendices.

Some functions, such as ferrous discrimination and determination of target depth, are not included as part of the Application Software. Users will need to create their own functions, using the channel data as input, in order to make full use of the data from the X-channels.

4.1 Installation

The Minelab STMR Application Software supplied is designed for MS Windows ® 2000/XP environments. Installation of the application software is a straight forward process. Simply follow the steps outlined below...

- To avoid any errors during installation, any previous version(s) of the STMR application must be uninstalled. To uninstall the application, run the '**Add/Remove Programs**' MS Windows program and remove the '**Minelab STMR**' entry.
- Insert the supplied CD into the CD drive of the computer that will be used in the field for data collection.
- Run the '**Setup.exe**' program.
- Click the '**Next**' button on each screen to accept default installation, or specify desired folder location if a non-standard installation is required.
- The installer will now set up the software and will add shortcuts to the 'Start' menu.
- Remove the CD once installation is complete and store in a safe location.
- Start the application software by clicking on the '**Minelab STMR**' icon in the start menu or on the desktop, or by executing '**FoxtrotPapaDeltaSierra.exe**' in the "C:\Program Files\Minelab\STMR\" directory.
- Any log files the user creates will by default be stored in the "C:\Program Files\Minelab\STMR\Log\" directory.
- When run the first time, any installed firewall may ask for approval. The STMR application requires bi-directional TCP and UDP access to ports.

4.2 Setup

Now that the software is installed and running, there are various configuration items that need to be initialised to suit the specific operational requirements. Setup of the software is via the tabs that appear on the right side of the application software window after pressing the ‘**Setup Tabs**’ button as shown in the figure below.

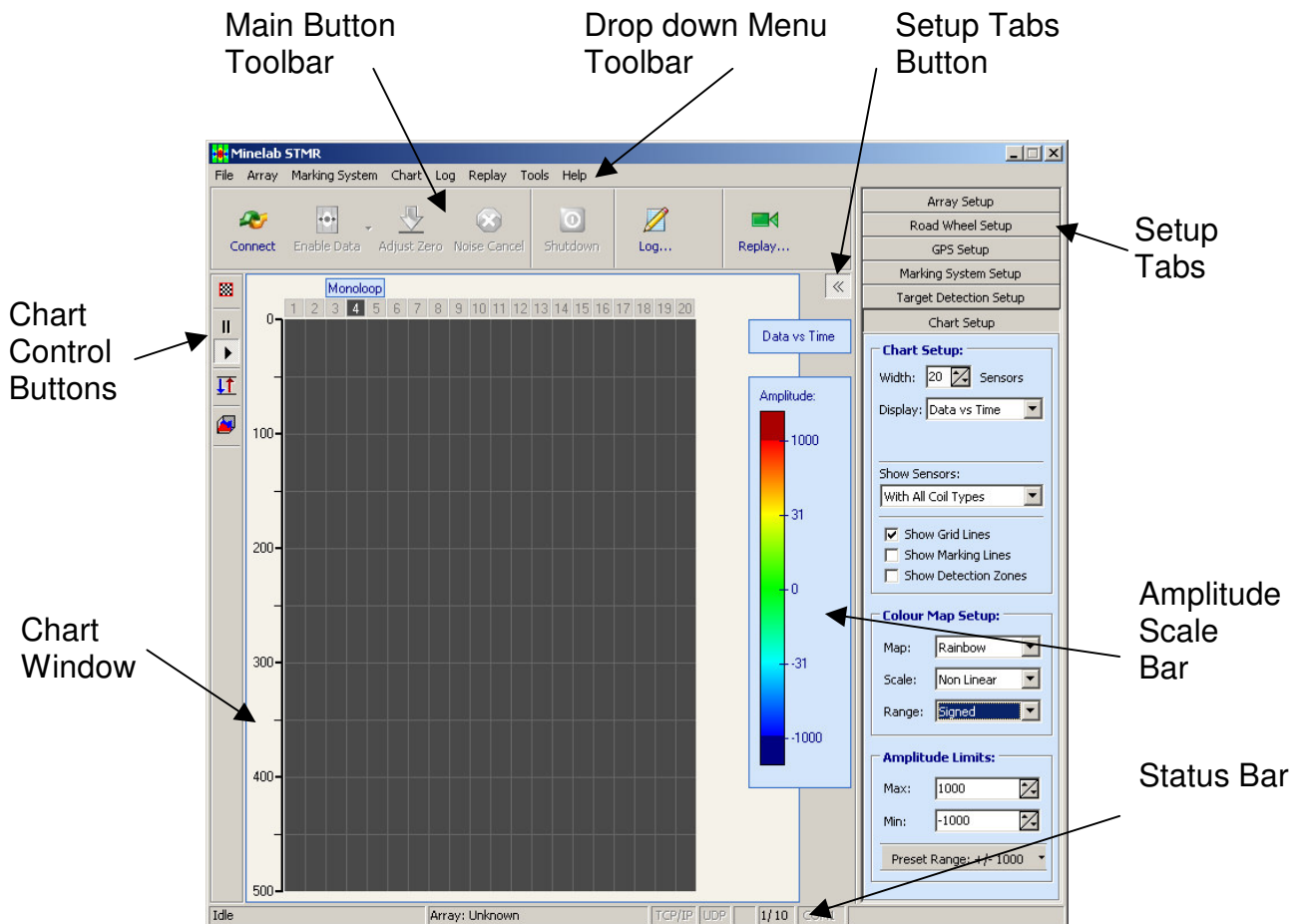

Figure 4.1

The button with two arrow brackets pointing to the left or right is the ‘**Setup Tabs**’ button and can be found on the right hand side of the screen, just below the ‘**Replay**’ button and above the ‘**Amplitude**’ scale bar. Pressing this button will switch on the setup tabs that will appear to the far right of the window. The setup tabs allow the user to initialise various parameters to customise the system for use.

There are six setup tabs, each of which allows access to various groups of parameters and settings. These tabs are described below.

4.2.1 Array Setup Tab

This is where the Ethernet IP address of the control box is set, as well as the number and type of Rx coils.

The screenshot shows the 'Array Setup' window. At the top, the title bar reads 'Array Setup'. Below it, the 'Array IP Address' section has a text field containing 'Unknown' and a 'Change...' button. The 'Number of Coils' section features a spin box with the value '20'. The 'Coil Map' section lists 20 coils, each with two radio buttons: 'Monoloop' (selected for all) and 'Figure 8'. At the bottom, there are two buttons: 'All Monoloop' and 'All Figure 8'.

Figure 4.2

- **‘Array IP Address’:** The STMR array contains a static IP address which should be set to the value as indicated on a tag or label attached to the Control box at time of manufacture. Click on this button and enter the IP address so that the application software can establish communications with the Control box. Ensure the network mask of the computer is set correctly to allow communications to occur. Changing the IP address of the system is described under section 4.5.2
- **‘Number of Coils’:** Use this control to match the application to the number of Rx coils the STMR array system has connected. Note that every Rx cable is connected to two coils, regardless of whether they are Monoloops or Figure ‘8’s.
- **‘Coil Map’:** By default, all Rx coils are assumed to be of Monoloop (ML) configuration, which is the standard shipment option. Special orders of the STMR array may include some Figure ‘8’ (F8) coils, so this map needs to be set to match the hardware configuration. If there are ML-F8 pairs, the odd-numbered elements of the Coil Map refer to the F8 windings, the even-numbered the ML windings. The two buttons at the bottom allow quick changes of setup to standard options. Right-clicking the mouse in this screen provides further options such as setting mono coils to odd or even numbers.

4.2.2 Road Wheel Setup Tab

This screen displays the trip meters for the road wheels (A and B) and is where calibration of the number of 'ticks' per metre is initialised.

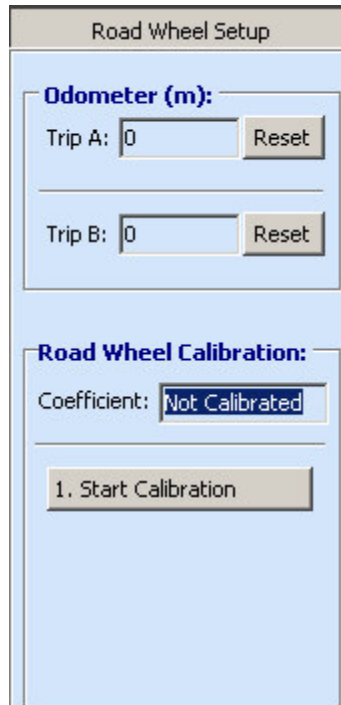

Figure 4.3a

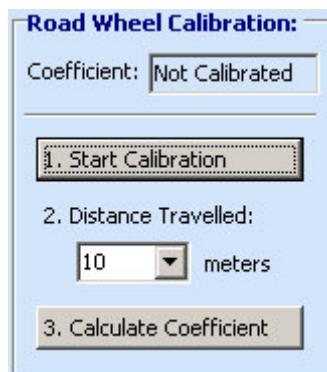

Figure 4.3b

- **'Trip A' & 'Trip B'**: These windows displays the total number of metres the road wheel. Only one wheel 'A' is supported at this time. The 'Reset' buttons set these counters back to zero.
- **'Road Wheel Calibration'**: This window displays the calibration factor to convert road wheel ticks to metres.
- **'1. Start Calibration'**: Pressing this button starts the calibration process for the road wheels. The application software must have a valid connection established to the Control box, and have data enabled with the road wheel connected in order to carry out this procedure.

To use a road wheel, the calibration procedure must be completed as described below...

- Mark out an accurate distance on the ground, normally 10, 50 or 100m.
- Place the road wheel / vehicle at the 0m mark
- Click **'1. Start Calibration'**
- Select the distance the road wheel will travel for calibration from the drop-down menu.
- Move the road wheel in a straight line and stop exactly on the end marker.
- Press the **'3. Calculate Coefficient'** button which will convert the number of clicks received from the road wheel to a coefficient which will be displayed in the **'Coefficient'** box and stored in the initialisation file.
- Calibration is now complete

The road wheel can be tested by selecting **'Data vs Distance'** in the **'Chart Setup'** tab followed by moving the array forward then backward to confirm scrolling on screen target information in the forward direction, and no scrolling data in the backwards direction.

4.2.3 GPS Setup Tab

Displays current GPS information and shows a brief history of recent GPS data packets. To setup a connection to a GPS refer to Appendix A2.2 as this information is contained within the config files.

The screenshot shows a software interface for GPS configuration. It is divided into three main sections: 'GPS Setup', 'Latest GPS Coordinates', and 'GPS History'. The 'GPS Setup' section has two input fields: 'Updates' (set to 'Once per second') and 'Type' (set to 'GPGGA'). The 'Latest GPS Coordinates' section has six input fields: 'Latitude' and 'Longitude' (both set to 'Unknown' with a small 'X' icon to the right), 'Quality', 'Satellites', 'Type', and 'UTC Time' (all set to 'Unknown'). The 'GPS History' section is a large empty text area. At the bottom right of the window is a 'Clear' button.

Figure 4.4

- **‘GPS Setup’**: Information relating to how often the GPS data is updated and what type of data frame is communicated is set here. These parameters can be modified in the ‘Sensor’ config file and cannot be modified from this screen.
- **‘Latest GPS Coordinates’**: As the title suggests, this window displays the last received set of co-ordinates from the attached GPS. This information is updated when new data are received, and an indication of the signal quality and location accuracy is also given. Current UTC time, as last received, is also displayed.
- **‘GPS History’**: This is a text box that displays the last few GPS data frames, for user reference. When a target detection occurs (refer to section 4.2.5) the next GPS text frame will change to a red colour. Pressing the button marked **‘clear’** will empty this screen ready for new data.

When powering up the STMR array and GPS, it may take up to 10 minutes for the GPS receiver to lock onto enough satellites to produce valid data. To view GPS data, GPS frames must be enabled (refer to section 4.3.1).

Note: GPS frames are written to log files (when enabled), but no interpolation of target data occurs – that is, the written frames are simply a time and location ‘stamp’ and target data between these log entries will not necessarily be evenly spaced by distance travelled, as entries to the log continue irrespective of vehicle speed or movement.

4.2.4 Marking System Setup Tab

Communications port setup for an optional external marking system is controlled here. The threshold above which a target detection triggers an output is also adjusted in this window.

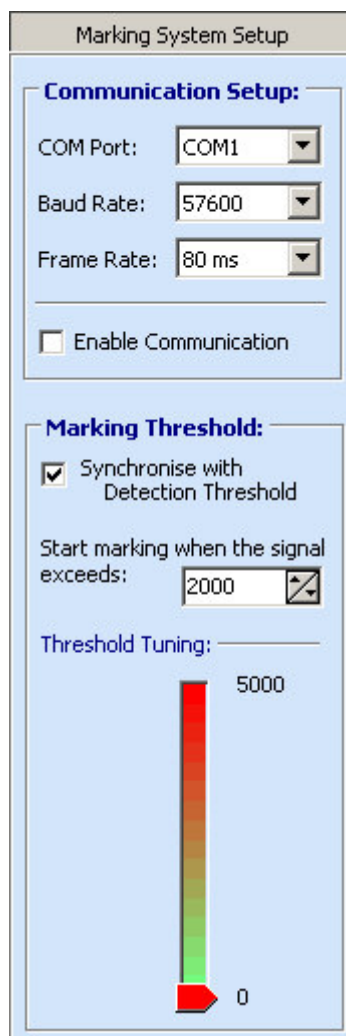

The screenshot shows the 'Marking System Setup' window. It is divided into two main sections: 'Communication Setup' and 'Marking Threshold'.
In the 'Communication Setup' section, there are three dropdown menus: 'COM Port' is set to 'COM1', 'Baud Rate' is set to '57600', and 'Frame Rate' is set to '80 ms'. Below these is an unchecked checkbox labeled 'Enable Communication'.
In the 'Marking Threshold' section, there is a checked checkbox labeled 'Synchronise with Detection Threshold'. Below this is a text box labeled 'Start marking when the signal exceeds:' with the value '2000' entered. At the bottom of this section is a 'Threshold Tuning' slider. The slider has a red arrow at the bottom pointing to '0' and a '5000' label at the top. The slider bar is currently positioned at approximately 2000.

Figure 4.5

- **‘COM Port’**: Use this window to set the communications port to which an external road marking system is attached.
- **‘Baud Rate’**: Set the communications baud rate as required by the external road marking system hardware.
- **‘Frame Rate’**: Set how often a trigger condition can be communicated to the external marking system hardware.
- **‘Enable Communications’**: Use this check box to enable output of data on the specified port when the marking threshold is exceeded. When ticked, the application attempts to open the port. If the port is not available or is locked by another application, an error dialog box will be shown.
- **‘Marking Threshold’**: This box displays and sets the level which a target signal must exceed for a trigger condition to be communicated to the external marking system. The level can be adjusted either by typing the desired number of counts into the text box, adjusting the number with the up and down arrows, or by dragging the slider on the graph.
- **‘Synchronise...’**: This check box sets and links the marking threshold to the ‘Target Detection Setup’ threshold. When ticked, the last modified value from either this or the ‘Target Detection Setup’ tab will be used.

To use an external marking system, the ‘Marking Algorithm’ must be selected in the ‘Target Detection Setup’ tab, otherwise no targets will be indicated to the external system. Refer to section 4.3.7 for further details.

4.2.5 Target Detection Setup Tab

This screen allows the user to select what type of Rx channel data is used to generate the display and activate a marking system (if installed). The detection threshold is also set here. Any signal exceeding it causes a 'detection event' which is recorded in log file records of targets. The threshold for the Marking System is set separately, unless the 'Synchronise' check box in 'Marking System Setup' is ticked, as described in Section 4.2.4 Marking System Setup Tab. A 'detection event' also displays a thin red bar (see section 4.2.6) that appears during the detection period adjacent to the right hand side of the main waterfall chart window.

The screenshot shows the 'Target Detection Setup' dialog box. It is divided into three main sections:

- Data Processing:** Includes four checked checkboxes labeled G, S, C, and X. Below them is a 'Data Processing' dropdown menu currently set to 'Raw Data', and a 'Channel Selection Criteria' dropdown menu set to 'Largest Modulus'.
- Detection Threshold:** A text input field with the value '2000' and a small icon to its right.
- Coils:** A grid of 20 checkboxes, numbered 1 through 20, all of which are checked. Below the grid are three buttons: 'All', 'All Mono', and 'All Fig.8'.

Figure 4.6

- **'Data Channels':** The four check boxes allow the user to select which Rx channels from the coils are used for target detection and display.
- **'Data Processing':** This drop-down box allows setting of the algorithm to be used for data display and marking system processing.
 - **Raw Data:** Un-processed data straight from the control box
 - **Absolute Value:** This selection does not affect positive (+) target signals, but converts all negative (-) target signals to positive values.
 - **Algorithm 1:** Not used at this time.
 - **Algorithm 2:** Not used at this time.
 - **Marking Algorithm:** Same as 'Absolute' except that this must be selected to trigger an external marking system and display Marking Lines.
- **'Channel Selection Criteria':** When more than one Data Channel is selected, this determines how the channels are combined for display and marking system trigger.
 - **Largest Modulus:** Compares the absolute values of each selected channel, and displays the greatest, but with its original sign.
 - **Largest:** Displays the largest (most positive) data from any selected channel.
 - **Smallest:** Displays the smallest (most negative) data from any selected channel
- **'Detection Threshold':** Set the level a target signal must exceed before registering a 'Detection Event'.
- **'Coils':** By default, all coils are monitored in order to determine a valid target threshold detection, but individual coils can be selected here. The three buttons at the bottom allow for quick access to standard setups.

4.2.6 Chart Setup Tab

How the Rx data is interpreted and displayed on screen in the main chart window is controlled here. The number of sensors displayed, and the technique used to display them can be set, along with various graphical attributes.

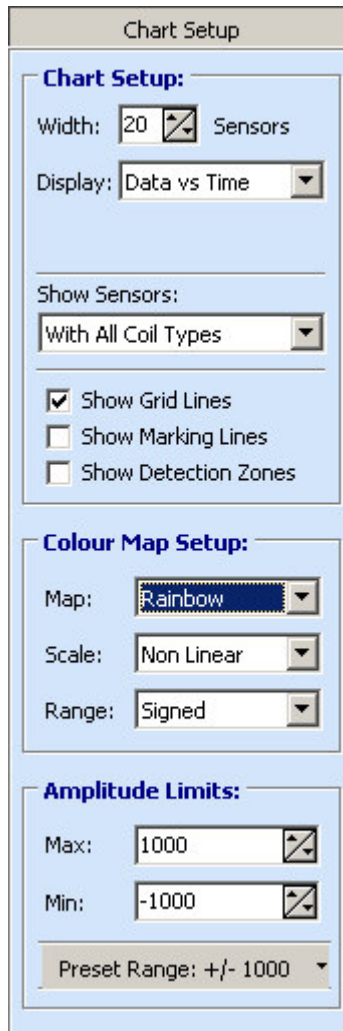

Figure 4.7

- **‘Width’**: Sets the number of Rx coils from 1 to a maximum of 20 to be displayed across the width of the chart and should, normally, match the number of installed Rx coils.
- **‘Display’**: Specifies the type of chart display. Screen update can occur regularly, in time or with wheel distance measured. The former will continue to scroll the screen even when the vehicle is stationary, while the latter will scroll at a speed proportional to the vehicle movement and will stop when the vehicle does. Note: with update determined by distance, the display will not scroll while the vehicle is moving backwards.
- **‘Show Sensors’**: This drop-down menu allows selection of which coil types the user wishes be displayed on the main chart. All coils, Monoloop only or Figure ‘8’ only, can be selected. This setting only applies to special versions of the STMR array, while for normal builds that are supplied with only Monoloops the user should select one of the first two options.
- **‘Show Grid Lines’**: Tick this box to display grid lines on the main chart window
- **‘Show Marking Lines’**: Tick this box to add a column on top of each Rx coil data stream to indicate when each coil triggers the marking system threshold.
- **‘Show Detection Zones’**: A tick in this box will activate a thin red bar that appears to the right hand side of the main chart waterfall window when the displayed data in any channel exceeds the ‘Detection Threshold’. It is activated only for positive (+) detection values.
- **‘Colour Map Setup’**: This group of drop-down boxes allows selection of data colour type for the chart, whether the scale is to be displayed as linear or logarithmic, and whether target signals should be signed or absolute. Signed data display shows both positive and negative data values, whilst Absolute displays both positive and negative target signals as the positive, un-signed values.
- **‘Amplitude Limits’**: This sets the display limits for the chart. Maximum and Minimum levels can be set independently, allowing observation of details of channel data with large offsets. The Minimum level setting is not available if the range is set to Absolute.

- **'Preset Range'**: this button gives the option of various preset chart scales. Simply click to select the desired scale or click the down-facing arrow, to the right of the button, to adjust the setting. Right-clicking the mouse over the 'Amplitude' scale bar will provide similar options.

4.3 Operation

Once the application software has been configured to match the user's requirements it is time to display some real data. When first run, the application software will power up with the main screen displayed and a few of the large buttons at the top of the screen greyed out.

4.3.1 Main Buttons

The top row of buttons control the most common operational functions of the STMR array.

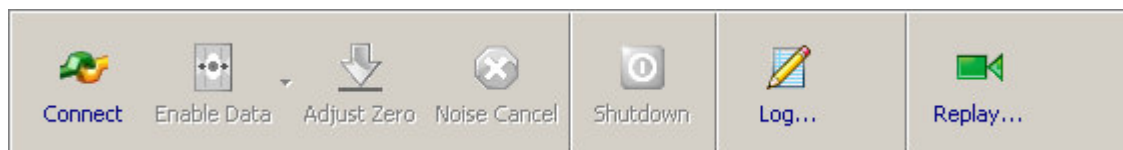

Figure 4.8

- **Connect:** Establishes communications with the STMR array. Pressing the 'F2' button will perform the same function.
- **Enable Data:** After the Control Box 'Tx On' led has lit, this button will begin the output of data from the STMR system and starts the on screen display. Pressing the 'F3' button will perform the same function. Clicking on the small arrow to the right of this button allows the user to select whether this button enables Rx data, GPS data or both when pressed.
- **Adjust Zero:** Applies an offset to each Rx coil output data stream so it is centred around zero for a clear display. Pressing the 'F4' button will perform the same function.
- **Noise Cancel:** Initiates a frequency band sweep to determine the quietest frequency for the STMR array to operate at. This helps reduce interference from external sources. Pressing the 'F5' or 'F7' buttons will perform the same function.
- **Shutdown:** Initiates the staged shutdown of the transmitter prior to powering down the STMR array.
- **Log:** Setting of folder and file name for the Log file to be stored is accessed from here. Once set, additional buttons become visible to allow record, pause and stop functions to be performed.
- **Replay:** This button allows the user to retrieve a log file and display it on screen.

4.3.2 Enabling Data

To begin the data display, firstly a connection to the STMR array is required. It is assumed that the correct IP address has been entered into the Array Setup IP address box and that the computer IP address and mask are set accordingly. It is also assumed that the control box has had all wiring connections made and that the Tx and Rx coils are connected as described in sections 2.2 and 2.3

- Start by pressing the '**Connect**' button
- 'Connected' should appear in the status bar at the bottom of the screen along with green 'TCP/IP' and 'UDP' text
- Along side the 'UDP' text a red heart shaped icon should appear. This indicates a regular 'heart beat' from the STMR array is being received.
- Press the '**Enable Data**' button and the columns in the main chart window should begin to scroll.
- Normally due to the inherent and unique offsets in each of the Sensor Card Rx channels, the columns will vary in colour. Press the '**Adjust Zero**' button and all columns should turn green.
- Wave a metallic target, like a screw driver or coin, over the coil from one end to the other. The main chart window should show the progression of the target across the coil through the changing of colour in the columns.
- The STMR array is now operational!

Now that the data have been enabled and are being displayed on screen, the various chart types and display options can be investigated.

4.3.3 Chart Window

Below the main buttons is the primary chart area on which the Rx coil data will be displayed once data are enabled. At the top of the chart are numbers 1 through 20, indicating to which coil number that column of chart data below it pertains. To the left of the chart window are the chart control buttons, and to the right is the '**Amplitude**' scale bar that indicates the scale of the displayed data by matching colours to certain signal amplitudes (in counts).



Reset Chart: Clears the main chart and starts scrolling with fresh data



Pause: Stops the flow of chart data until 'Play' is pressed. While paused, hovering the cursor over the chart will display the amplitude of data at that point.



Play: When the chart is paused, this button will re-start the display



Auto Scale: This button resets the chart scale based on the amplitude range of data currently displayed in the chart window. The maximum limit is set to just above the highest data count and, likewise, the minimum limit is set to just

below the lowest data count. Clicking this button can be very useful when viewing non-zero data by centring the display area around the offset data.



View Relief Chart: This button opens a new window to show a snap shot of all current Rx coil traces in a 3D-style relief line chart.

The Rx data can also be displayed in a 2D scrolling line style chart by selecting the 'Chart' drop-down menu followed by 'View 2D Chart', described in the next section.

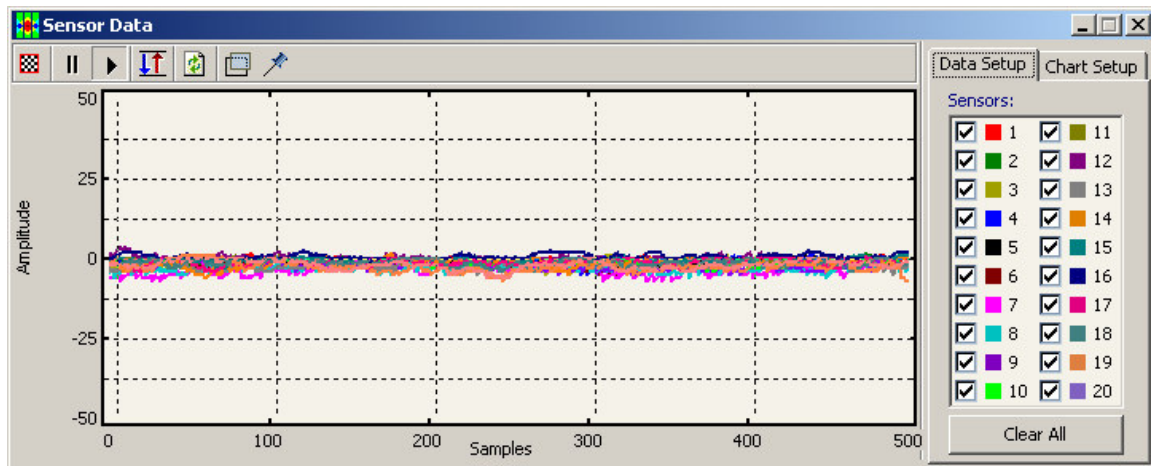

Figure 4.9

Each Rx channel can be switched on and off by selecting the required check boxes in the 'Data Setup' tab window. Each trace colour is different and shows the signals from a particular Rx coil. The 'Data Setup' tab window indicates which colour is associated with which coil number.

Right-clicking the mouse will provide short-cuts to useful selection options, such as selecting only Figure '8' coils for display, or selecting only Monoloop coils for display.

There are three new buttons on this chart window...



Refresh: Updates the chart window with the latest data



Transparency: Toggles the 2D chart window between opaque and transparent mode. This allows viewing of the main screen through the 2D chart window if desired. This function requires greater amounts of processing than normal operation, so may slow the performance of some computer systems.



Stay on Top: Pressing this button locks the 2D chart window as the active view, so it will not go to the background if another application software window is selected or made active.

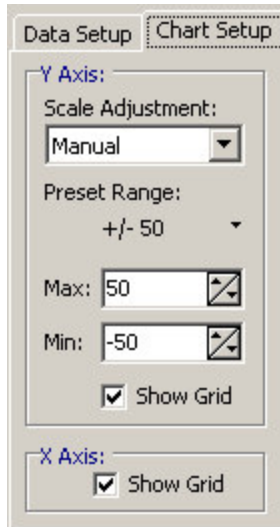

Figure 4.10

The scale of the chart window can also be changed so that all data can be viewed together, or selected Rx responses can be zoomed in for closer examination.

This can be achieved in two ways. Firstly, through right click of the mouse and selection of the required pre-set range, or secondly the user can adjust the chart display range by entering the required values in the '**Chart Setup**' Tab window.

- **Scale Adjustment:** The user can select 'Manual' so that values can be entered, 'Auto Scale' for a one time snap shot adjusting of the limits to display current screen data, or 'Continuous Auto' to begin updating of the display limits for each new data packet received.
- **Preset Range:** Select one of the preset +/- display limit ranges
- **Max / Min:** User can set manual limits here. They do not have to be symmetrical.
- **Show Grid:** These check boxes toggle the on-screen grid lines.

4.3.4 Drop-down Menus

Above the main buttons are the standard tool bar controls, which access log files and setup information. The help file can also be accessed here which describes all aspects of the application software. Many of these selections are an alternative means of accessing the setup tabs that appear to the right hand side of the window.

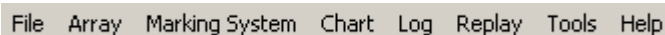

Figure 4.11

- **File:** Allows the user to exit the program.
- **Array:** Displays the current STMR array configuration and allows sending of specific commands to the control box (described in section 4.4). Also provides alternative means of accessing the Setup tab and establishing communications.
- **Marking System:** Provides access to setup and control of the external marking system triggering parameters. Refer to section 4.2.4 & 4.3.7 for details.
- **Chart:** Provides chart control commands and access to the two other chart types for display of Rx data: 2D line chart and pseudo 3D relief chart.

- **Log:** Provides the same access to log file setup and control as the 'Log' button as described in section 4.3.6.
- **Replay:** Provides the same access to log file retrieval and control as the 'Replay' button as described in section 4.3.6.
- **Tools:** The TCP server, the configuration files and the Power Supply monitoring windows can be accessed through this menu. Refer to section 4.5 for more details.
- **Help:** Starts the help file so the user can read this manual.

4.3.5 Reading & Interpreting data

The default main chart settings produce a display of each Rx data stream using a signed non-linear display range. If desired, the user can change this through the 'Chart Setup' tab as described in section 4.2.6. This provides additional means of interpreting the displayed data.

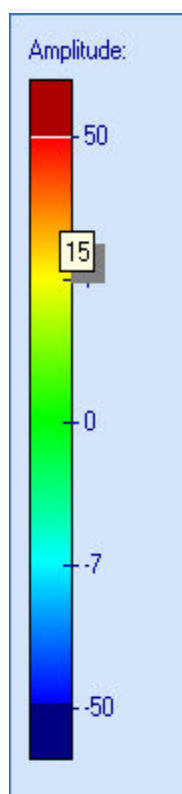

Figure 4.12

To further allow greater flexibility in analysis of data, required Rx channels for each data stream can be selected through the 'Target Detection Setup' tab as described in section 4.2.5. For monoloop coils only **G**, **S** and **C** channels contain useful data as **X** is reserved for Figure '8' coils.

As each column of the main chart window displays data by changing colour, the user can more accurately determine the corresponding number of data point 'counts' by clicking the matching colour in the '**Amplitude**' display bar. This will pop up the respective number of 'counts'.

Setting the limits of the chart display too low will result in a loss of information as large targets will produce data beyond those limits. A setting too high will result in small targets not being obvious in the display. Similarly, setting the target detection threshold for a marking system too low could result in many false targets, while setting it too high could result in missed targets.

Normally, the limits of the chart display should be set just high enough to fully display the response from the targets expected to be detected. The experience a user gains within their working environment is the best guide to adjusting these display and threshold levels.

Logged data is not affected by limits of the display and can be replayed with different limits later.

4.3.6 Log Files

All data received from the STMR array system can be logged to a user-specified ASCII XML file for retrieval and viewing at a later stage. Irrespective of chart window settings, all Sensor data streams and channels are stored to file, along with GPS and Road Wheel data, if enabled. See Appendix A2.3 for details of the file structure.

To log array data

- Connect to the STMR array system
- Enable array data frames
- Open the **‘Log’** dialog window
- Click the Folder button .
- Specify the log file and folder location
- Select the **‘Delimiter’** to be used to separate data in the log file. The delimiter *Tab* is the preferred option if you are going to use MS Excel to view the log files.

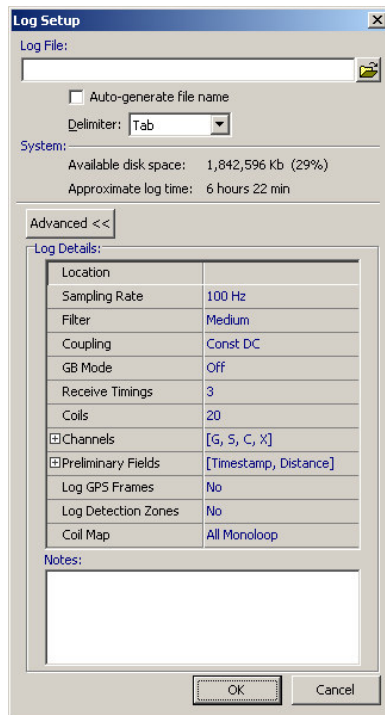

Figure 4.13



If desired, the advanced settings can be modified in the **‘Log Details’** window. The settings selected will be stored as part of the log file. The application will automatically pre-fill some of the fields with the current array configuration (i.e. Sampling Rate, Coupling, Timings, Coils, etc).

One such option allows the user to select the **‘Channels’** and **‘Preliminary Fields’** that you want to store in the log file. If required, you can exclude any unwanted channels/fields from being logged. This will make the log file smaller.

Notes can be added to the window at the bottom for inclusion in the log file. Do not place ampersand symbols (&) in the Notes section, as this may confuse some XSL transformation software.

GPS data will only be logged if GPS Frames are enabled. Refer to section 4.3.1 for details.

To start the logging

- From the **‘Log’** drop-down menu, select **‘Start’**, or click the  button
- Once the logging is started, the size of the log file is displayed on the status bar. Note, that a log file can be infinitely long and it is the user’s responsibility to make sure that the hard drive has enough free space.
- During the logging, storing of data can be paused by pressing the  button and can be re-started by pressing the  button

To stop the logging

- From the **'Log'** drop-down menu, select **'Stop'**, or click the  button

To review logged data

- From the **'Replay'** drop-down menu, select **'Setup'**, or click the **'Replay'** button
- Select the log file to display and click **'Ok'**
- From the **'Replay'** drop-down menu, now select **'Start'**, or click the  button
- The Main Chart window will now replay the data from the log file. Progress will be shown in the status bar and the bottom of the screen.
- All normal Chart window settings are available

To stop replay of log file data

- From the **'Replay'** drop-down menu, select **'Stop'**, or click the  button

4.3.7 Marking system

If a third-party external marking system is to be used, the STMR application software must be configured through the 'Marking System Setup' tab. This can be accessed directly through clicking on the tab, or by selecting 'Marking System' followed by 'Setup...' from the drop-down menu bar. Refer to section 4.2.4 for setup details.

As there are many possibilities for external marking systems, the user must ensure the system can accept and process the data protocol used by the STMR application software. Please refer to appendix A2.4 for details.

Once configured and enabled, the STMR application software will continuously output data of value '0', whether the array is moving or stationary. When a 'detection event' occurs, a bit corresponding to the coil that recorded the detection will be activated in the data stream for as long as the detection continues. More than one coil can activate its corresponding marking nozzle simultaneously.

If 'Show Marking Lines' has been enabled in the 'Chart Setup' tab, then a white line in the middle of each coil channel displayed in the main chart window will be drawn that corresponds with the detection event.

Note: No marking lines will be displayed on screen and the RS232 data will continue to output '0' if the 'Marking Algorithm' has NOT been selected.

Under the drop-down menu option, there are two useful commands that can be activated and deactivated as required by clicking on the selections...

- 'Enable Lane Markers' – sets a bit in the output data that can be used to activate tow nozzles at the extremities of the detection area to indicate the lane that has been swept by the STMR Array.
- 'Enable Nozzle Test' – sets a specific bit in the output data packet that can be used to activate all nozzles for testing purposes.

4.3.8 Shutting Down

When the user has finished detection activities and wishes to power down the STMR array, Minelab recommend clicking the '**Shutdown**' button before switching off the front panel or 'remote' power switch. This initiates a orderly shutdown of the transmitter and power supplies. Refer to section 3.4.3 for more details.

There are four methods of issuing the 'Shutdown' command...

- Click the '**Shutdown**' main toolbar button
- Select '**Send Command**' followed by '**Shutdown Power Supply**' from the '**Array**' drop-down menu
- Press '**F10**' on the keyboard
- Press a momentary button connected to the shutdown pins of the '**AUX**' front panel connector (not supplied). Refer to Appendix A1.2 for pin out details.

4.4 Array Commands

4.4.1 Data frames

This command allows the user to instruct the STMR Array to start, or stop, sending Rx data frames. This is similar in function to the '**Enable Data**' button.

4.4.2 Noise cancel

The STMR Array is an electro-magnetic sensor and, as such, is susceptible to electro-magnetic interference. If the interfering signal is rapidly drifting in frequency, then the interference will be present for a relatively short period of time and nothing needs to be done. If the interference is persistent, then issuing a '**Noise Cancel**' command will instruct the array to scan the available range of frequencies, in order to find an electro-magnetically quiet region. At the end of the scan, the array will select the quietest operating frequency and inform the host computer that the procedure has been completed.

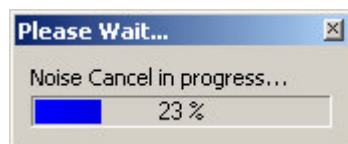

Figure 4.14

There is a very small change in the sensitivity of the array between the extremes of the operating frequency range, similar to that of the hand-held detectors. Because of the fast decrease of the target signal with depth, this translates into an extremely small change in the maximum detection depth – virtually undetectable under practical operating conditions.

4.4.3 GPS frames

This command allows the user to instruct the STMR Array to start sending GPS data frames, or to cease doing so. This is similar in function to the '**Enable Data**' button, but should be initiated only once configuration files have been updated. Refer to the example in section 4.5.2.2 for details.

4.4.4 Coupling

The hardware in the array is DC coupled. If a target is brought into the vicinity of the sensor head, the change in the analogue levels will be present as long as the target remains. Some detectors (eg. F1A4) are AC coupled, making them 'motion detectors' – they detect only when there is relative motion between the target and the sensor head. The analogue outputs of the Sensor cards have different DC offsets due to a number of causes (electronics, coils etc) and these offsets are susceptible to temperature-induced drift. It is desirable to eliminate these offsets and this is done through the options offered in 'Coupling'. In the following explanation, the 'input signal' means the digitised signal applied to the coupling algorithm and 'output' represents the signal produced by the coupling algorithm.

- **AC:** This option simulates the operation of ‘motion detectors’. The running average of the signal is subtracted from the input signal. The output signal will always return to zero after the target is removed or if the target stops moving. It has the undesirable effect of ‘smearing’ the targets, but is immune to problems affecting other types of coupling (like temperature-induced drift). Effectively, this option applies a ‘high pass filter’ to the channels. This introduces a great deal of lag in the response, especially from large targets. The time constant of the high pass filter is not suitable for slow detection speeds.
- **DC:** This option has no effect on the signal - output equals input. Each channel will have its own steady-state value that can drift slowly in time. It gives the real value of the analogue signals, so saturation of channels can be detected.
- **Pseudo DC:** This option tracks very small DC offset drift with a very slow low pass filter. Tracking is suspended while the coil is over a target. This offset is then subtracted from the input signal to centre the data around zero. Stopping for a long period of time over a target or starting over a target can, potentially, defeat the operation. The channels are zeroed when the command is selected, so it is recommended to do so when no targets are present. This option should only be used for development purposes as drift tracking occurs only within a very narrow range.
- **Const DC:** This option zeroes the channels every time it is selected, but it does not track any changes in offset. It is useful for on-line viewing or off-line analysis of data, as data from all sensors is aligned from the moment the option is selected. This command can be issued at any time to update the value of these constants. This mode is automatically initiated when the ‘Adjust Zero’ button is clicked.

The ‘Const DC’ command can be executed as many times as required and is the recommended coupling type for most situations. This command is best executed in a metal free area just prior to recording any data and any time offsets become too great.

4.4.5 Filter

It is possible to select one of several cut-off frequencies for the low-pass filters in the receivers. The nature of these filters is described in the STMR Specifications document. Currently these filters are supplied with approximately 1.5Hz, 3Hz and 10Hz cut off frequencies.

- **Slow** (1.5 Hz filter) - For operation up to 3 km/h and increased height above the ground, the 1.5 Hz filter reduces the level of noise and the susceptibility to electro-magnetic interference. An increased delay in target response may also be noticed.

- **Medium** (3 Hz filter) - For operation up to 5 km/h and nominal height above the ground, the 3 Hz filter is recommended.
- **Fast** (10 Hz filter) - For operation at higher speeds or for targets swept rapidly in the immediate vicinity of the sensing head, the 10 Hz filter is recommended, although it will incur some noise penalty. The 10 Hz filter is also recommended if the post-processing software includes its own low-pass filtering or some other form of signal processing.

It is possible to change the filters during operation, producing a transient lasting not more than 0.25 seconds. The filters are gain matched in software, however changing the filters produces a change in offset that requires coupling to be updated.

4.4.6 GB mode

The STMR array system inherently reduces the effect of mineralised ground on target signals. This allows operation in areas that would normally present large amounts of 'ground noise', preventing detection of targets. As such, no further adjustments need to be made at this time to compensate for mineralised ground.

The Ground Balance commands available through the drop-down menu are included for future development, should the need arise, and should not be used at this time. The default position is 'None' and neither of the other options should be selected.

4.4.7 Sampling rate

There are four options for sample rate: **25** samples/second, **50** samples/second, **100** samples/second and **200** samples/second. Choosing one over another is a system-level consideration based upon third-party post-processing requirements. The sample rate can be changed while in operation.

4.4.8 Receive Timings

There are four different timing sets available that the user can select. These timings adjust the Sensor card Rx channels and how targets are detected and interpreted. Two of the timing sets are specifically for Monoloop (ML) only coils (standard configuration), while the other two timings sets are for a combination of Monoloop & Figure '8' (F8) coils (special-order configuration).

- **Timings 0:** Normal Timings. These are for ML-only coils and are for general use.
- **Timings 1:** Conservative timings. These are also for ML-only coils but are conservative in nature and are intended for use in mineralized ground where there are problems with too much ground signal leaking into the target channels.

- **Timings 2:** Normal combination ML and F8 timings. These are based on timing set 0, except that the X-channel is configured to receive during the Tx pulse on the F8 coils, providing additional target information.
- **Timings 3:** Conservative combination ML and F8 timings. These are based on timing set 1, where the timings are adjusted for mineralized ground, but the X-channel for the F8 coils remains the same as in timing set 2.

4.4.9 Shutdown power supply

This command initiates an orderly shutdown of the transmitter and power supplies, as described in section 3.4.3.

After issuing this command, and the ‘**Tx On**’ LED has extinguished, the array can be shut down completely by switching the ‘**Power**’ switch to ‘Off’, or by opening the connection between the remote on/off pins on the ‘**Power**’ connector.

4.4.10 Query setup

This command allow direct issuing of a request for the STMR array to return all current hardware settings such as Coupling type current selected, number of installed coils, etc. This command is automatically issued by the STMR application software every time another command is sent, and can be used to confirm change of status.

Use of this command in a direct manner does not result in any display of data and is intended for software development and debug use only

4.4.11 Transmitter

Under normal conditions the Transmitter will switch on when the STMR system is powered up, and will switch off when the ‘**Shutdown**’ command is issued or power to the system is removed. This command allows the user to switch the transmitter on and off during operation, and is not generally used under normal conditions.

4.4.12 Power supply frames

By default, the PS Micro board in the Control box sends data frames to communicate the levels of the internal voltage rails and the status of lower assembly components. This command allows the user to switch off these data frames, and in so doing, disable the functionality of the ‘**Power Supply Monitor**’ tool, which will cease to update. Under normal operating conditions these data frames should be switched ‘on’ so that operational status can be checked if desired.

4.4.13 Statistics

This command tells the STMR array to return data used to monitor the status and general 'health' of each Rx Sensor Card. Use of this command, in a direct manner, does not result in any display of data and is intended for software development and debug use only

4.4.14 Configuration

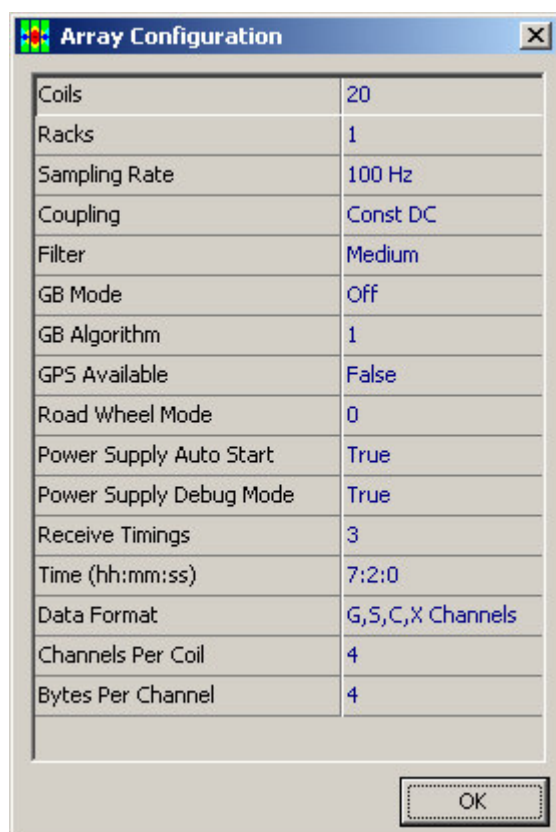

After commands have been issued to the STMR array, all current settings can be viewed simultaneously by selecting the 'Array' drop-down menu, followed by 'Configuration'. A window similar to Figure 4.15 will appear. This window simply displays data pulled from the STMR system control box – settings cannot be changed from here.

Figure 4.15

4.5 Tools

One of the drop-down menu tool bars at the top of the window is the 'Tools' menu. This menu gives access to various functions or user information windows that can assist in third-party software development and diagnosis of faults.

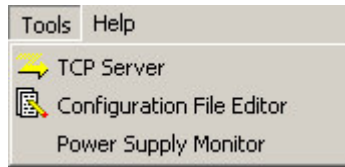

Figure 4.16

- The 'TCP Server' allows direct monitoring of Controller card status messages.
- The 'Configuration File Editor' allows the user to change settings in the embedded hardware configuration files.
- The 'Power Supply Monitor' opens a window to display internal hardware power supply rail voltages and the states of flag conditions that indicate operational status of the system. This information is updated in real time and also provides a scrolling chart to show changes over time, if desired.

4.5.1 TCP Server

The TCP Server application is used to monitor Controller status messages. Normally, the Controller outputs status messages via an internal RS232 connector, located on the Controller board. However, in normal operation the RS232 connector cannot be easily accessed. The TCP Server tool makes it easy to display the Controller status messages, as it uses the Ethernet connection and does not require opening the control box.

Before the TCP Server tool can be used, the array Controller must be configured to output status messages via Ethernet, not via RS232. As some startup time is required to establish an Ethernet connection, some very early messages are lost.

To configure the Controller to output status messages to the TCP Server

- Determine the IP address of the PC that will run the TCP Server application.
- Run the Configuration File Editor application and download the '**Debug.conf**' file from the Controller (see section 4.5.2)
- Find the line which specifies the IP address of the TCP server:
#+ DebugServerAddress = ??? . ??? . ??? . ???
- Replace the "???. ??? . ??? . ???" with the IP address of the TCP Server
- Delete the # symbol. This activates the definition of the **DebugServerAddress** variable. For instance, if the IP address of your PC is 123.68.6.244, the line in the Debug.conf shall be:
+ DebugServerAddress = 123 . 68 . 6 . 244
- Upload file to the Controller and power off the STMR array.

When powered back on the Controller will try to connect and forward all status messages to the TCP Server. Ensure the server is running before powering on the STMR array.

To view the Controller status messages with the TCP Server application

- Ensure the Controller has been configured for the TCP connection (see above) and switched off.
- Run the TCP Server application by selecting the 'TCP Server' from the 'Tools' drop-down menu.
- Ensure the status bar indicates the 'Listen Port' as '52000'. Otherwise this will need to be set through the 'Setup' drop-down menu, followed by 'Listen port'.

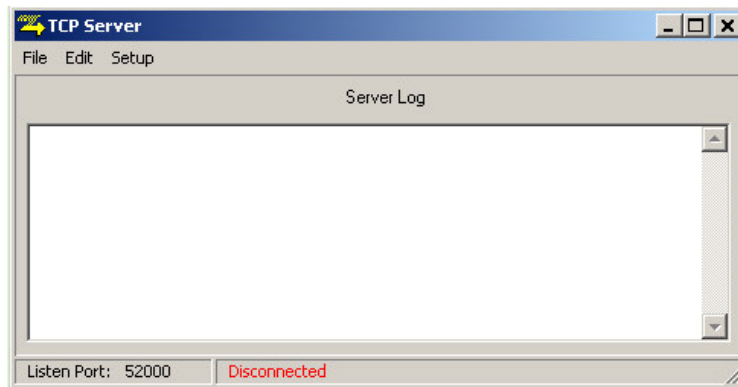

Figure 4.17

- Switch on the Array. The Controller will automatically connect to the TCP sever and the controller status messages will appear on the *Server Log* window.

WARNING

If the Controller has been configured to output status messages to the TCP Server and the **TCP Server application is not running**, the Controller start-up time will take more than a minute. This will result in the array system being unresponsive for a long time after the power-up.

If the TCP Server is not used, it is recommended to configure the Controller to use default output (RS232) for status messages.

To configure the Controller to use default output (RS232) for status messages

- Determine the IP address of the PC that will run the TCP Server application.
- Run the Configuration File Editor application and download the '**Debug.conf**' file from the Controller (see section 4.5.2)
- Find the line which specifies the IP address of the TCP server:
+ **DebugServerAddress** = ????.????.????.???
- Add a '#' symbol to the beginning of the line. This de-activates the definition of the **DebugServerAddress** variable.
- Upload file to the Controller and power off the STMR array.

When powered on the Controller will no longer try to connect and forward status messages to the TCP Server.

4.5.2 Configuration File Editor

The Configuration File Editor is a tool for modifying configuration files of the array system. The configuration files are stored in the file system of the array Controller. These files contain setup parameters (configuration) of the array. At power-up the Controller reads the configuration files and configures all the modules of the array system (sensors and the power supply unit).

The three configuration files are stored in the Controller. To edit them, they must firstly be downloaded to the PC using the Configuration File Editor. Once downloaded, they can be edited, then uploaded back to the Controller. Copies of the files can also be saved to the PC for easy reference.

- **Ethernet.conf** – contains array IP address etc.
- **SensorCntrl.conf** – contains Sensor and Power Supply configuration parameters.
- **Debug.conf** – contains the IP address of the Debug server.

To download a configuration file...

- Run the Editor application by select 'Configuration File Editor' from the 'Tools' drop-down menu.
- Ensure the STMR array is running and a connection is already established.
- Enter the IP address of the STMR array – the same one as entered during the Array Setup stage.
- Select the 'Remote File' to download.
- Click the 'Download' button and the file text will be displayed on screen.

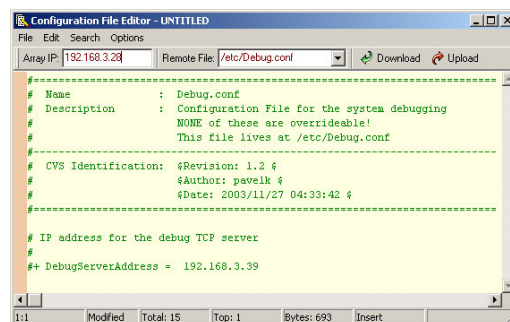

```
Configuration File Editor - UNTITLED
File Edit Search Options
Array IP: 192.168.3.23 Remote File: /etc/Debug.conf Download Upload
#-----#
# Name      : Debug.conf
# Description : Configuration File for the system debugging
#           : NONE of these are overrideable!
#           : This file lives at /etc/Debug.conf
#-----#
# CVS Identification:  $Revision: 1.2 $
#                   : $Author: pavelk $
#                   : $Date: 2003/11/27 04:33:42 $
#-----#
# IP address for the debug TCP server
#
#+ DebugServerAddress = 192.168.3.39
#-----#
1:1 Modified Total: 15 Top: 1 Bytes: 693 Insert
```

Figure 4.18

To update an array configuration file:

- Saving the original file on the PC, before editing, is recommended.
- Configuration files contain three types of data:
 - **Comments** – any line of the configuration file with a '#' symbol in the first position. You can freely modify comments or add your own, as they are ignored by the Array.

- **Variables** – configuration parameters used by the Controller. All Variables are located on the separate lines which start with the ‘+’ symbol and end with the equal sign ‘=’. **The names of the variables must not be changed.**
- **Values** – numbers, which follow the **variables**. The values can be modified in order to change the configuration parameters. Normally, the acceptable range of values is specified in the comment line(s) above the variables.
- Make changes to the configuration file.
- You can also save a copy of the edited file on the PC via ‘File’ menu.

To upload a configuration file...

- Click the ‘**Upload**’ button to transfer the updated file back into the Controller. This will overwrite the original configuration file in the Controller file system.
- NOTE: Be VERY careful to upload the correct file under the correct name to the STMR array as any file will be accepted and the system could be made non-operational.
- Now reset the STMR Array by powering down and back up again to implement the changes.

Typical examples of the three configuration files are given below for reference...

4.5.2.1 Ethernet.conf

```

=====
# Name          : Ethernet.conf
# Description    : Configuration File for the Ethernet settings
#               : NONE of these are overrideable!
#               : This file lives at /etc/Ethernet.conf
#-----
# CVS Identification: $Revision: 1.3 $
#                   $Author: pavelk $
#                   $Date: 2003/11/27 04:33:41 $
#-----

# MAC ID for this unit
# This must be specified in hex WITHOUT leading 0x
+ HostMACId = 02:f1:a4:9f:e4:31

# IP_ADDRESS for this unit
+ HostIPAddress = 192.168.2.5

# Net mask
+ HostNetMask = 255.255.255.0

# Broadcast IP address
+ HostBroadcast = 192.168.2.255

```

4.5.2.2 Sensorctrl.conf

```
#####
# Name          : SensorCtrl.conf
# Description    : Configuration File for the Nemesis Backplane Controller
#               : This file lives at /etc/SensorCtrl.conf
#-----
# CVS Identification: $Revision:$
#                 $Author:$
#                 $Date:$
#-----

# Number of the racks in the array system (currently must be set to 1)
+ NrRacks = 1

# Number of the sensors in the rack (2..20). Must be an even number as there are two sensor
circuits per sensor card. Ten cards = twenty sensors.
+ NrSensors = 20

#-----
#           S E N S O R Configuration Parameters
#-----
# Specifies Sensor cards used in the array:
# (1 - STMR MK II sensor hardware: two coils per sensor CPU, 0 - old STMR MK I sensor
hardware)
+ NewSensorHw = 1

# Size of data from the Sensors (1,2,4 bytes representing byte,int16,int32). Must currently be
set to 4.
+ datasize = 4

# Sampling frequency to be used in Hz: 50, 100, 200
+ samplefreq = 100

# FIR type: (0 - slow, 1 - medium, 2 - fast)
+ firtype = 1

# Coupling: (0 - AC, 1 - DC, 2 - Pseudo DC, 3 - Const DC)
+ coupling = 3

# Output data format for each sensor:
# (3 - three channels, 4 - four channels, 20 - four channels of test data). Three channels
excludes the 'X' channel and is typical for monoloop configurations
+ datacfg = 3

# GB mode: (0 - off, 1 - fixed, 2 - tracking)
+ gbmode = 0

# GB algorithm to use: (currently must be set to 1)
+ gbalgorithm = 1

#-----
#           P O W E R S U P P L Y Configuration Parameters
#-----
# Default settings for time and timestamping
+ Year = 2007
+ Month = 6
+ Day = 8
+ Hour = 7
+ Minute = 2
+ Second = 0

# Is there communication with a GPS? (1 - Yes, 0 - No)
# If set to 1, the Power Supply will be generating timestamps using GPS time.
# If set to 0, the Power Supply will be generating timestamps itself.
# NB: If set to 1 and GPS unit is not connected to the system, erroneous timestamps
# will be generated
+ GPSAvailable = 0

# The Baud rate of the serial communication with the GPS
+ GPSBaud = 19200

# The initial distance setting for the Road Wheel
+ Distance = 0
```

```

# The Mode of the wheel transducing the distance:
#   (0 - Not Available, 1- Uni Phase, 2 - Dual Phase)
+ WheelMode = 0

# Debug Mode: ( 0 - Off, 1 - On).
# In debug mode the controller will keep polling data sensors when
# the transmitter is down/switched off. It's not to be used for normal
# operation as receive timings won't be shutdown if a transmitter malfunction
# happens.
# When debug mode is OFF the controller shall not poll data sensors if the transmitter
# is not on.
+ Debug = 0

# Auto Start Mode: ( 0 - Off, 1 - On).
# In Auto Start mode the controller will try to enable the transmitter automatically,
# after the controller power up.
# If Auto Start mode is OFF, the controller shall wait for the Host command to
# enable the transmitter.
+ AutoStart = 1

# Transmit Timings used by the transmitter: (0..3)
+ TxTimings = 0

# Number of power levels used by the power supply to ramp up the tx voltage: (1..8)
# This number corresponds to the percentage of the tx power
+ NrTxPowerLevels = 7

#-----
#           C O N T R O L L E R Configuration Parameters
#-----
# Receive Timings used by the controller: (0..3). Timings 0, 1 for Mono/Mono; Timings 2, 3 for
Fig 8/Mono.
+ RxTimings = 0

#
#   Backplane Communication Timeouts
# These timeouts define the time the Controller will spend waiting for a reply
# from a backplane slave(Sensor or PS).
# These numbers are loop counters, no direct relationship with milliseconds etc.
# Rough estimation 1000 - 0.7ms, 10000 - 7ms
# Timeouts for the Power Supply
- PsIdentTimeout = 8000
- PsCfgTimeout = 4000
- PsDatapollTimeout = 1000
# Timeouts for the Sensors
- SensIdentTimeout = 2000
- SensCfgTimeout = 8000
- SensDatapollTimeout = 2000

#
#   Noise Cancel settings
#
# The coil to take readings from for noise cancel. If it is absent the NC won't start
# and will return an error. Must be an even number: 2, 4, 6, 8, 10, 12, 14, 16, 18, or 20
+ NC_CoilToSample = 6

# The channels to be used for noise cancel:
#   1      - use channel S only
#   1+2    - use channels S and C
#   1+2+3  - use channels S, C, and X
+ NC_Channels = 1+2

# Delay after the first (maybe big) change to the VCO before noise cancel starts
+ NC_InitialFIRDelay = 100
# Values to account for VCO changes to travel through the FIR
+ NC_FillFIRSamples = 20
+ NC_DrainFIRSamples = 20
# Range to move the VCO over
+ NC_VCOMin = 1
+ NC_VCOMax = 4095
# Should be smaller then NC_VCORamp_BigStep
+ NC_VCOStepSize = 1
# Which channel carries the Ground data
+ GroundChannel = 0
# First noise level to search for quiet runs

```

```

+ NC_SearchNoiseMin = 2
# Noise inc (and shift adjustment) between search steps
+ NC_SearchNoiseStepSize = 2
+ NC_SearchNoiseShift = 2
# Total number of bins (used to define the bin width)
+ NC_NrBins = 256
# Number of bins from which to choose the best
+ NC_NrSortedBins = 10
# Search steps (should not be so high that all readings would be below the noise!)
+ NC_SearchNoiseSteps = 10
# if 1 and too many search steps (all readings are below the noise) then
#     will automatically reduce the steps
# if 0 then leave the search steps alone
+ NC_SearchNoiseAutoAdjust = 1
# How far the raw and LPF data is shifted right to become the HPF value
+ NC_HPFFNoiseShift = 4

# VCO ramping values
# Delay between small steps (under VCORamp_BigStep) in milliseconds
+ NC_VCORamp_SmallStepDelay = 0
# Maximum step size (bigger steps are broken into big steps)
+ NC_VCORamp_BigStep = 110
# Delay between big steps in milliseconds
+ NC_VCORamp_BigStepDelay = 10

```

4.5.2.3 Debug.conf

```

=====
# Name          : Debug.conf
# Description    : Configuration File for the system debugging
#               : NONE of these are overrideable!
#               : This file lives at /etc/Debug.conf
#-----
# CVS Identification: $Revision: 1.2 $
#                   $Author: pavelk $
#                   $Date: 2003/11/27 04:33:42 $
#-----

# IP address for the debug TCP server
#
#+ DebugServerAddress = 192.168.3.39

```

4.5.3 Power Supply Monitor

The Power Supply Monitor is a tool that examines the data sent by the PS Micro board to determine the level of each internal voltage rail, and the status of the transmitter. All of this information is displayed using simply indicator 'lights' that can be off (grey), on and good (green) or on and bad (red).

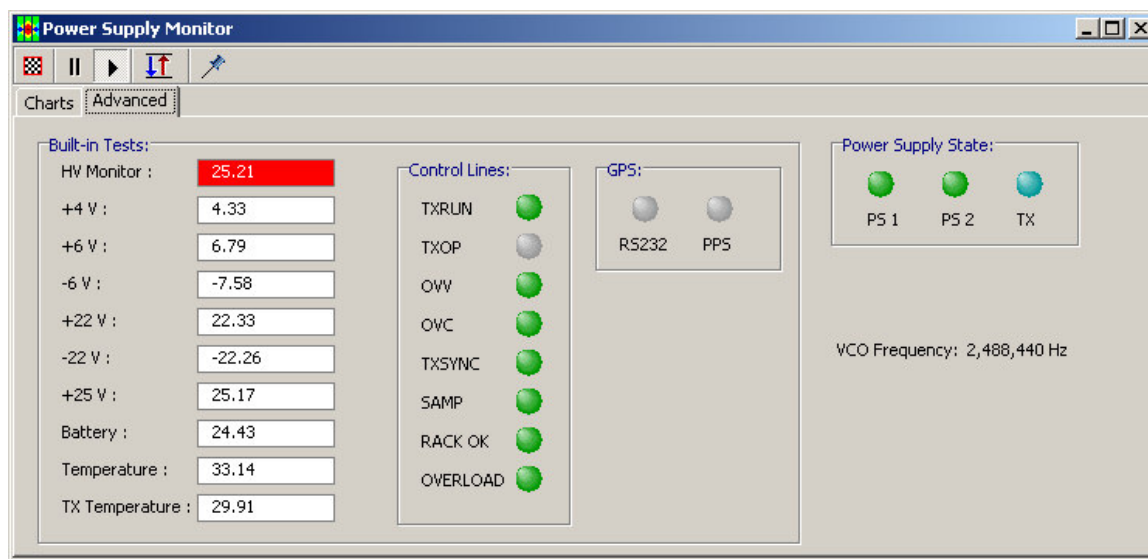

Figure 4.19

The first column continuously displays rail voltages. Note, however, that if the STMR array is not operating under the normal automatic mode (for instance, the 'Shutdown' button has been pressed) then some or all of the voltages may be reported as 'not measured'. Figure 4.19 shows a typical display when running in automatic mode, but without the transmitter coil connected; thus the HV is reported as only 25V instead of 475V, and is thus shaded red.

The second box 'Control Lines' contains status lights which stay grey in colour when not being monitored because of system status, but change to green when operating. Any red coloured lights could indicate a fault; contact Minelab if this occurs.

The third box 'GPS' contains lights that indicate the communications status with an external GPS. If one is connected, both should be green.

The final box 'Power Supply State' contains lights to indicate whether three major bottom assembly components are currently running: Power supply1, Power supply 2, and the Transmitter. When fully operational, all three will be green in colour. Again, in the example of figure 4.19, the TxOP light is a green/grey indicating Tx is on, but not operational as the coil is not connected.

Just below the 'Power Supply State' box the frequency of the main oscillator is displayed. This is the frequency that changes during Noise Cancel.

Appendix 1: Front Panel Connectors

The front panel of the STMR array has many sockets for connection of coils, power and auxiliary devices. It is the responsibility of the user to ensure the wiring of plugs connected to these sockets complies with the pin connections detailed in this appendix. If in doubt about connecting a device or wiring loom, please consult Minelab.

A1.1 Power Switch

The Power Switch has three positions.

- **On:** Turns the STMR Array power On
- **Off:** Turns the STMR Array power Off
- **Remote:** Hands the power on / off control over to an external remote switch which can be connected to pins in the 'Power' socket as described below. Shorting the two pins together results in turning the STMR array On

A1.2 Power Socket

24V power from the vehicle battery is applied to this point. If a remote power switch is to be used, it also connects to this socket.

Wall mount receptacle type MS3112 E 14-12 P
Mating Connector straight plug MS3116 F 14-12 S

Function	Pin Assignment
+24V	M
0V	K
Rem0V	E
RemOn	F
ChassisGnd	L

Viewed from Front of Panel Socket,
Rear of Line Plug

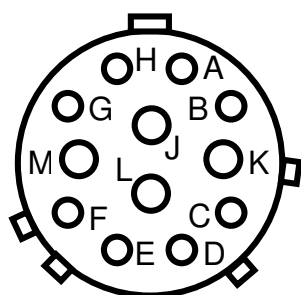

Viewed from Front of Line Plug,
Rear of Panel Socket

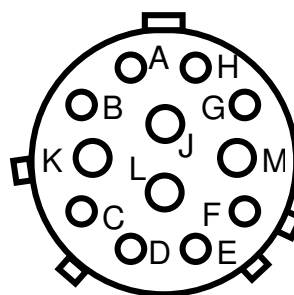

The array runs from a nominal 24V. The specified range is 22-28VDC. The ChassisGnd wire must be connected to the ground of the vehicle, preferably close to the Control box. It connects to the electronics enclosure, which should be electrically isolated from the vehicle ground, to avoid the possibility of forming ground loops.

When the '**Power**' switch is in the 'Remote' position the STMR array can be powered on by shorting the '**Rem0V**' and '**RemOn**' pins together. Only connect these two pins to a switch or relay contacts - do not connect to any power source, battery or other device. Note that these two pins are duplicated in the Auxiliary connector.

A1.3 Ethernet

This socket is used to connect to a 100-Base Tx Ethernet network. It is an Amphenol 'RJ Field' connector. The RJ Field connector is capable of accepting a standard RJ45 plug without an environmental seal if required.

Wall mount receptacle type RJF 21 G
Mating Connector straight plug RJF 6M G

A1.4 Road Wheel

A rotary encoder can be connected if required. The interface is designed primarily to accept differential RS485 type connections from a quadrature style rotary encoder. Depending on software settings either quadrature signals or a single tick can be used. Single ended signals can be used when the matching '-' pin is biased to approx 3V using resistors between pins A and B – consult Minelab for details if this is required.

The nominal 6V line is capable of supplying approx 200mA.

Wall mount receptacle type MS 3112 E 10-7 S
Mating Connector straight plug MS 3116 F 10-7 P

Function	Pin Assignments
0V	A
+6V	B
PosA+	C
PosA-	D
PosB+	E
PosB-	F

Viewed from Front of Panel Socket,
Rear of Line Plug

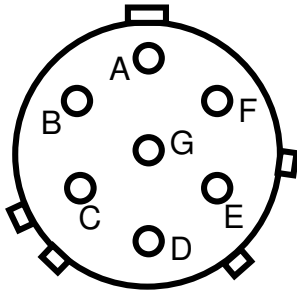

Viewed from Front of Line Plug,
Rear of Panel Socket

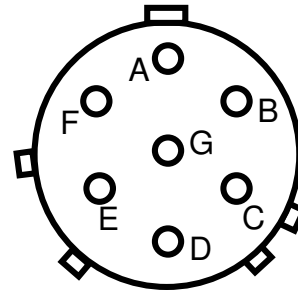

A1.5 GPS

A configured GPS receiver can be connected to this point if required. The hardware is configured to suit either RS422 or RS485 receive and transmit. If a single ended PPS signal is to be used this must be applied to GPPS+, then GPPS- must be configured to approximately 3V.

Wall mount receptacle MS 3112 E 12-10 S
Mating Connector straight plug MS 3116 F 12-10 P

Function	Pin Assignments
0V	A
+6V	B
GPSTx+/GPSTx	C
GPSTx-	D
GPSTx+/GPSTx	E
GPSTx-	F
GPPS+	G
GPPS-	H

Viewed from Front of Panel Socket,
Rear of Line Plug

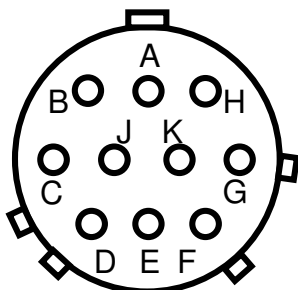

Viewed from Front of Line Plug,
Rear of Panel Socket

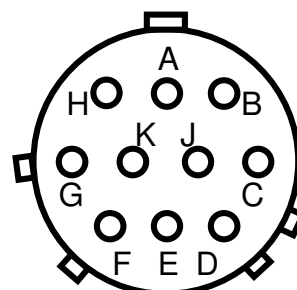

As shipped the array is designed to be connected to RS485 signals using pins C/D and E/F. By modifying the board an RS232 serial connection can be established. Consult Minelab if this is required, or if unipolar transmission is to be used to connect the PPS signal to the array.

A1.6 Auxiliary

This connector can be used to communicate directly with the PS Micro board and to monitor the high voltage rail within the power supply. The Rem0V and RemOn pins from the 'Power' socket are duplicated in this connector from the power connector.

Wall mount receptacle MS 3112 E 12-8 S
 Mating Connector straight plug MS 3116 F 12-8 P

Function	Pin Assignments
EngTx	A
EngRx	B
SigGnd	C
HVMon	D
Rem0V	E
Shutdown	F
RemOn	G

Viewed from Front of Panel Socket,
Rear of Line Plug

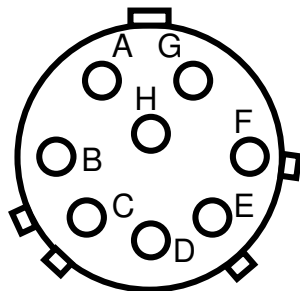

Viewed from Front of Line Plug,
Rear of Panel Socket

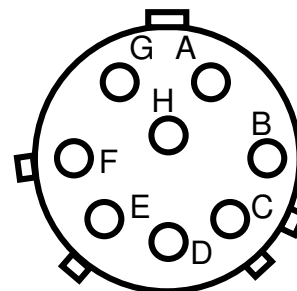

The internal +475V rail is scaled down by a factor of 100 such that 4.75V on the 'HVMon' point is equivalent to a high voltage of 475V.

An external momentary 'Shutdown' button or relay contacts can be connected to pins 'F' and 'C'. These pins serve the same function as clicking on the 'Shutdown' icon in the Minelab Application Software, as described in section 4.3.8.

A1.7 Rx Coils

Careful construction of the Rx coil cables to minimise noise and interference requires factory made connections. Please consult Minelab if replacement or modified cables are required.

Wall mount receptacle Bulgin PX0707/S/12
 Mating Connector straight plug Bulgin PX0794/P

A1.8 Tx Coils

Careful construction of the Tx coil cables to minimise noise and interference requires factory made connections. If the user is winding a custom Tx coil, additional information will be provided regarding connection to the Tx plug. Please consult Minelab if replacement or modified cables are required.

Wall mount receptacle MS 3100 F28 - 15S
 Mating Connector straight plug MS 3108 F28 - 15P

Function	Pin Assignment
GND	T
JL	A, C, D, H, J, P, R, X, Y, d, e, j
JS	F, G, M, N, V, W, b, c g, h, k, m

View from Front of Line Plug, Rear of Panel Socket

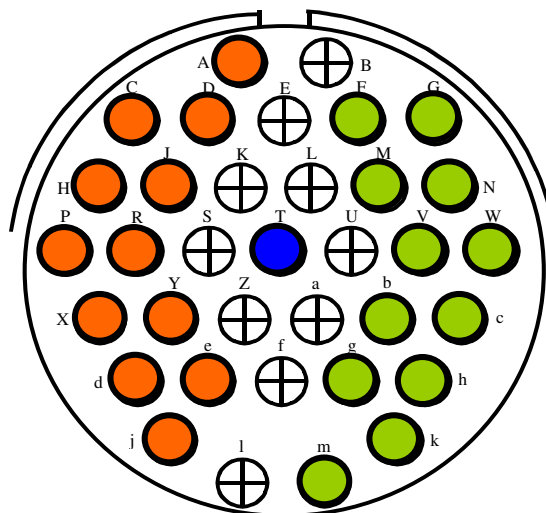

Appendix 2: Data Protocols & Software Specifics

This section contains more detailed information on the technical requirements and construction of data frames and other software related issues.

A2.1 Application Software Installation Files

By default, the application files and directories are placed in "C:\Program Files\Minelab\STMR\" directory during installation. The contents of the directory are as follows...

- "\Program Files\Minelab\STMR\" directory contains executable files of the main application and tools, as well as DLLs required to run the application.
- "\Program Files\Minelab\STMR\Conf\" directory contains the default configuration files used to configure the array system upon start-up. These files can be used by the "Configuration File Editor" tool to control the configuration of the array system.
- "\Program Files\Minelab\STMR\Log\" directory contains the XSL style sheet file (mdf2csv.xsl), which is required when opening the log files (*.mdf) with the MS Excel application. This directory can be also used as a repository of the log files.

A2.2 GPS Data Frames

The array currently decodes the NMEA 0183 Version 2, Global Positioning System Fix Data ASCII sentence. The structure of this sentence is shown below...

```
$GPGGA, <1>,<2>,<3>,<4>,<5>,<6>,<7>,<8>,<9>,M,<10>,M,<11>,<12>  
*hh<CR><LF>
```

where...

- <1> UTC time of position fix in "hhmmss" format
- <2> Latitude, "ddmm.mmmm"
- <3> Latitude hemisphere, "N" or "S"
- <4> Longitude, "ddmm.mmmm"
- <5> Longitude hemisphere, "E" or "W"
- <6> GPS quality indication
0 = fix not available
1 = Non-differential fix is available,
2 = Differential GPS (DGPS) fix available
6 = Estimated
- <7> Number of satellites in use, "00" to "12"
- <8> Horizontal dillution of precision, "0.5" to "99.9"
- <9> Antenna height above/below mean sea level, "-9999.9" to "99999.9" meters
- <10> Geoidal height, "-999.9" to "9999.9" meters
- <11> Differential GPS data age, number of seconds since last valid RTCM transmission, (null if non-DGPS)
- <12> Differential Reference Station ID, "0000" to "1023"

(leading zeros transmitted, null if non-DGPS)
 "*hh" checksum

The UTC time is synchronised to the rising edge of the PPS signal from the GPS. This can be modified by Minelab at the time of manufacture through an internal DIP switch. The configuration file '**SensorCtrl.conf**' contains a setting that controls the speed of the serial data.

A2.3 Log File Format

The log files created are of an ASCII XML format with a .MDF extension. They are designed to contain information regarding the configuration, test location, etc, along with the data. The intent is that the log file will contain all the information required to identify and describe a given test.

Note that this is an early version of the log file format and later versions will contain more tags. In an XML system any unidentified tags are ignored.

The following text in *italics* are comments and are not a part of the data file.

<pre><?xml version="1.0"?> <?xml-stylesheet type="text/xsl" href="mdf2csv.xsl" ?> <Minelab_Data_File Version = "0.0.0.1"> <HEADER> <DESCRIPTION> <SYSTEM_NAME>FPDS</SYSTEM_NAME> <FULL_DESCRIPTION>tbd</FULL_DESCRIPTION> </DESCRIPTION> <LOCATION> <PLACE>Test Pit</PLACE> <TIME>2003-10-23T18:10:13+09:30</TIME> </LOCATION> <CONFIGURATION> <SAMPLE_RATE>100 Hz</SAMPLE_RATE> <COUPLING>Const DC</COUPLING> <GB_MODE>Fixed</GB_MODE> <FILTER>Slow</FILTER> <TIMINGS></TIMINGS> <DATA_FORMAT> <COILS>16</COILS> <CHANNELS> <G>True</G> <S>True</S> <C>True</C> <Q>True</Q> </CHANNELS> <PRELIM_FILEDS> <TIMESTAMP>True</TIMESTAMP> <DISTANCE>True</DISTANCE> <POSITION>False</POSITION> <LABELS>T,D,G1... </LABELS> </PRELIM_FILEDS> </DATA_FORMAT> </CONFIGURATION> <NOTES> No targets </NOTES> </HEADER> <D>14:10:00:000,0,1,0,0,1,-1,0,1,0 ...</D> <D>14:10:00:010,34,0,0,0,1,-1,0,1,0...</D> <D>14:10:00:020,68,-1,0,0,1,-1,0,1,0...</D> <D>14:10:00:030,102,0,0,0,1,-1,0,1,0...</D> </Minelab_Data_File></pre>	<p><i>Identification as XML file</i> <i>Pointer to XSL file for importing by Excel XP</i> <i>Top level tag with version number of file specification</i> <i>Header definition</i> <i>Description of test</i> <i>Name of system being tested</i> <i>Full description of test – not yet implemented</i></p> <p><i>Location description</i> <i>Description of test location</i> <i>Time could be UTC with date and zone info or local</i></p> <p><i>Configuration description</i> <i>Sample rate</i> <i>Coupling</i> <i>Ground Balance mode</i> <i>Selected Filter</i> <i>Selected Timings</i> <i>Definition of <D> tags</i> <i>Number of coil data columns</i> <i>Data columns included</i> <i>Is the G channel included in the log file</i> <i>Is the S channel included in the log file</i> <i>Is the C channel included in the log file</i> <i>Is the Q channel included in the log file</i></p> <p><i>Information fields included</i> <i>Is the timestamp field included in the log file</i> <i>Is the distance field included in the log file</i> <i>Is the Position field included in the log file</i> <i>Labels for each column of data in <D> tag (eg only)</i></p> <p><i>Miscellaneous notes</i></p> <p><i>Logged data (partial eg only)</i></p>
--	---

A2.4 Marking System Protocol

The STMR application outputs a continuous string of data once enabled. Each data packet is comprised of eight (8) bytes. The format for each byte is described below...

- byte #1: 0xAA – beginning of packet marker in hex
- byte #2: 0x55 – beginning of packet marker in hex (ASCII 'U')
- byte #3: 0x04 – beginning of packet number in hex
- byte #4: Data Bits 12..15 in ASCII equivalent hex
- byte #5: Data Bits 8..11 in ASCII equivalent hex
- byte #6: Data Bits 4..7 in ASCII equivalent hex
- byte #7: Data Bits 0..3 in ASCII equivalent hex
- byte #8: 0x00 – end of packet marker.

Thus bytes #4 through #7 contain marking info for up to 16 nozzles. Each mono and figure '8' coil is allocated a number and are encoded in ASCII equivalent hex from high bit to low bit in the following way...

Coil	Binary bit map	Hex number
0	0001	0x01
1	0010	0x02
2	0100	0x04
3	1000	0x08

Coils are counted in groups of four with a single byte representing the addition of 'marking condition' bits for the group. Thus if coils 3 and 2 register a marking condition, we add the numbers 8 and 4 together to output the hex number 'C'.

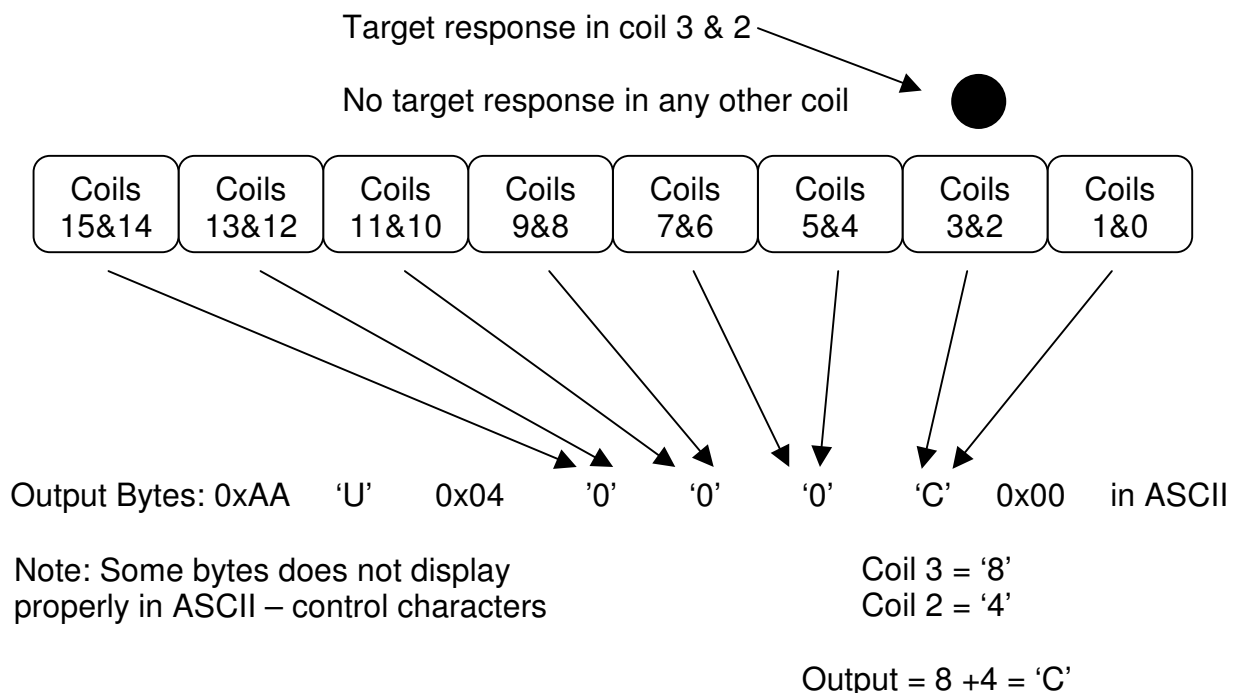

If no coils register a 'marking condition', the output data string of bytes 4 through 7 will be: '0000' in ASCII characters, or '30 30 30 30' in actual hex values.



Output Bytes: 0xAA 'U' 0x04 '0' '0' '0' '0' 0x00 in ASCII

Output Bytes: 0xAA 0x55 0x04 0x30 0x30 0x30 0x30 0x00 in hex

Up to 14 marking nozzles are supported (bits 0 through 13 of the 'marking bytes'), with bit 14 used to activate lane markers ('4' in ASCII hex in byte #4), and bit 15 used to enable all nozzles as a test feature ('8' in ASCII hex in byte #4). These two bits are activated by 'Enable Lane Markers' and 'Enable Nozzle Test' respectively from the drop-down menu. Selecting both outputs a 'C' in ASCII hex. Note: these two features share the bit definitions with coils #14 and #15 if installed and enabled, thus the user can select whether to use the described features or the extra Rx coils. If more than 15 coils are installed, no marker activity can be associated with the extra coils.

Appendix 3: Trouble-shooting

The STMR array is a complex piece of equipment, so users who are not familiar with the functionality might find some aspects of the setup and operation difficult. This section aims to address these issues by discussing some common problems that might be encountered.

A3.1 Can't Connect STMR Application To The Array

Start by directly connecting the STMR array to the host computer, without any hubs or switchers in the line. Make sure you use a cross-over cable and not a standard one, and check for 'Link' and 'Activity' LEDs being lit, or flashing, on the host computer.

The IP address of the array must be specified in order to establish the connection. To specify the array IP address in the application software, enter the IP address of the STMR array into the '**Array IP Address**' tool within the '**Array Setup**' tab. The IP address that has been entered will be displayed in the status bar at the bottom of the screen.

Next, ensure the IP address and Subnet mask of the host computer are set to match the STMR array. In essence, ensure the host computer IP address has the same first three numbers and the mask is set to '255.255.255.0'. For special circumstances consult a computer specialist or IT administrator.

Once the IP addresses are specified, you can connect to the array.

Now, connect to the array by pressing the '**Connect**' button

The status of the connection attempt will be displayed on the status bar. When the connection is established, the "**Connected**" message is displayed on the status bar next to the Array IP address, **AND** "TCP/IP" and "UDP" text turns green, **AND** the heart image starts pulsating.

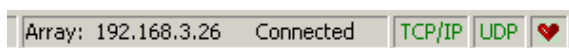

- The communication between the STMR application and the array comprises TCP/IP and UDP links: TCP/IP layer is used for sending commands to the array, and UDP link is used to receive array data frames. The status of these links is reflected with the colour of the "TCP/IP" and "UDP" text on the status bar: green = communication established; red = communication link is broken.
- The heart icon reflects the UDP heartbeat frames that are sent by the array system once every second. Note that once the Array begins transmitting data, the heart will no longer pulse. It may or may not be present, depending on the state of the icon when the data began transmitting.

If the connection has not been established, the status bar will display:



If Minelab STMR Application Does Not Connect

- Check that array IP address has been entered correctly in the ‘**Array Setup**’ dialog. The array IP address is normally specified in the **Ethernet.conf** configuration file, which is stored in the file system of the array Controller.
- Check that the Array system is switched on and the Controller LED is on and steady.
- Check the Ethernet cable.
- Using the DOS command ‘ping’, try to determine if the STMR array can be seen by the network and host computer.
- Check that there is only one instance of the Minelab STMR application running. The array does not support multiple Ethernet connections, so if an instance of the Minelab STMR is connected already, all other instances will fail to connect to the array.
- Ensure that the PC on which you run the application is on the same subnet (i.e. check the TCP/IP settings for the relevant network connection).
- Try pinging the default array IP address **192.168.10.180**.
- If the PC is directly connected to the array ensure that a crossover cable is used.

To disconnect from the array

- Select ‘**Disconnect**’ from the ‘**Array**’ drop-down menu
- Note, that the application will automatically try to restore the connection to the array after it has been broken.

No Communications – How to ‘Ping’

- Open a DOS window and attempt to ping the array using the DOS ping command eg. ping 192.168.3.28 or other IP address the array may be set to.

```
Usage: ping [-t] [-a] [-n count] [-l size] [-f] [-i TTL] [-v TOS]
        [-r count] [-s count] [[-j host-list] | [-k host-list]]
        [-w timeout] destination-list
```

Options:

```
-t          Ping the specified host until interrupted.
-a          Resolve addresses to hostnames.
-n count    Number of echo requests to send.
-l size     Send buffer size.
-f          Set Don't Fragment flag in packet.
-i TTL      Time To Live.
-v TOS      Type Of Service.
-r count    Record route for count hops.
-s count    Timestamp for count hops.
-j host-list Loose source route along host-list.
-k host-list Strict source route along host-list.
-w timeout  Timeout in milliseconds to wait for each reply.
```

- Ensure that the PC is on the same subnet, ie. check the TCP/IP settings for the relevant network connection.
- Try pinging the default IP address 192.168.10.180
- Try repeating the ping command a number of times to ensure that any intervening network infrastructure is aware of the network location of the array.
- If the PC is directly connected to the array ensure that a cross-over cable is used.
- Restart the array and repeat the above steps after waiting several minutes for the array to start up.
- If a switch or hub is used to connect the devices check the status LEDs on the equipment to determine the device that may not be connecting.

A3.2 Step changes in the Sensor Data

When viewing data on screen, a sudden jump in the Rx data may occur. This is usually due to an unexpected target, interference or power-up conditions...

- The transmitter may have not fully started. Check the status LEDs on the **'Front Panel'** and in the **'Power Supply Monitor'** tool. Data cannot be considered valid until the STMR system is fully operational and the front panel **'Tx'** LED is lit.
- A large target has been detected by the STMR array. Remember that anything metallic is considered to be a target, including objects above ground as well as below it. Metal water pipes, other vehicles, power lines, fences and buildings can all result in large target responses.
- If the displayed data is oscillating, it is likely due to external interference. Other metal detectors, vehicles, radios and particularly faulty or worn vehicle alternators can cause high levels of interference.
- The 'X' channel has been selected amongst those used for display of data. This channel works differently to the others, so when 'Largest Modulus' is selected, background noise and targets can produce strange displayed results that look like step responses. Refer to section 4.2.5 for details.

A3.3 Nothing Works

If the user is experiencing difficulty getting any response from the STMR array, the following points should be considered...

- Check that the input power is nominally 24V under load, that it is connected and the power switch is 'On'. This can be confirmed by the 'Power In' front panel LED being lit.
- If the front panel LEDs indicate normal power-up, check the Ethernet connection, the IP address and the subnet mask. Refer to Appendix A3.1

- If connection can not be established, connect the RS232 port of a computer running a terminal program (e.g. TeraTerm) to the PS Micro board through the *Auxiliary* connector as described in Appendix A1.6 and capture any output while the array starts up. Consult Minelab for assistance.

A3.4 Front panel LED problems

Under normal conditions, with the Tx coil connected, the front panel LEDs will light in the following sequence...

- Power In: Indicates 24V power connected and power switch is on
- PS/Tx Ok: PS Micro has booted up and is starting power supplies
- PS/Tx Comms: Initially flashes to show initial communications with the Controller card
- PS/Tx Comms, Controller, Sensor: After the initial PS/Tx comms LED flash, all of these should light approximately at the same time indicating full system electronics boot up and operation.
- Tx On: This LED will light after a minute or so once the Tx output has been increased to full power. All LEDs will now be on

If this sequence does not occur there are some points to consider...

- Power In Flashes: Internal overload or high resistance 24V supply. Start by checking the wiring back to the vehicle battery and ensure at least 22V is present under load. Even a momentary drop below this level may cause a reset.
- Controller LED flashes: This normally indicates a communications problem so switch power off, open the enclosure, withdraw the Controller card then re-insert and try again.
- Sensor LED flashes or is not on: Normally this means communications with a Sensor card can not be established. Try withdrawing and re-inserting the affected sensor card(s) or replacing with a spare if this does not rectify the problem.

For other problems, contact Minelab.

A3.5 Noisy Data

The STMR Array is an electro-magnetic sensor and, as such, is susceptible to electro-magnetic interference. If the interfering signal is drifting in frequency rapidly, then any interference will be present for a relatively short time and may be manifest as a false target response in all channels of all Rx coils. In this circumstance, the interference will simply disappear again and no action will need to be taken.

If however the interference is persistent, then a *Noise Cancel* command to the array will instruct the internal software to scan the available range of frequencies for a quiet region with the least interference. During this scanning operation, which takes around 90 seconds, the array cannot be used for target detection operations and the vehicle should be stationary with its engine and all normal devices running. At the

end of the scan, the array will select the quietest operating frequency and inform the host computer that the procedure has been completed.

There is a very small change in the sensitivity of the array between the extremes of the operating frequency range, similar to that of the hand-held detectors. There is sharp reduction of target signal with increasing depth; this means that a small diminution of target signal translates into an extremely small change in the maximum detection depth – virtually imperceptible under practical operating conditions.

Appendix 4: STMR Specifications

Physical – Sensor Head (ML – Mono-loop only)	
Monoloop Type (Standard)	Monoloop Rx Coils as Line Replaceable Units (LRUs) includes individual Rx modules and separate Tx sensor head assembly
Dimensions	Small: 1800x400x300mm (outside dimensions) Large: 3200x400x300mm <i>Note: Dimensions above include Carrier structure</i>
Weight	Approx. 17 kg (1800mm unit) Approx. 32 kg (3200mm unit)
Colour	US FED STAN 595B 33446 - "Desert TAN 686"
Physical – Sensor Head (ML/F8 – Clutter Rejection)	
Monoloop & Figure 8 (Optional)	One piece sensor head containing integrated TX and RX windings. RX windings comprised of ten pairs of mono / fig 8 coils.
Dimensions	Sensor head: 2140 x 608 x 70mm Sensor head with skid plate: 2200 x 900 x 121mm
Weight	Approx. 40kg including sensor head, carrier & skid plate
Colour	Dulux Premix GMH Light Buckskin, approximately matched to US FED STAN 595B 33446 - "Desert TAN 686"
Physical - Rx Coils (For ML Sensor Head only)	
Type	Two Mono-loop Coils per Rx module (paddle)
Dimensions	400x280x30mm per Rx module (outside dimensions)
Max Coils	20 Rx Mono-loops (10 paddles – 3200mm unit))
Weight	1.26 kg per paddle (includes two mono-loop windings and a common cable and connector)
Physical - Control Box	
Type	6U EDAK Mil Spec Enclosure
Dimensions	535x500x350mm
Weight	Approx. 25 kg
Colour	US FED STAN 595B 33446 - "Desert TAN 686"
Physical – Cables	
Type	Factory fitted. Max length: 6 m

Electrical Characteristics	
Power	22VDC to 28VDC (24VDC nominal), 5A (max)
Operating Frequency	1.25 kHz +/-3% PRF, 6 pulses per cycle
Transmit Power	475V, 15A (peak)
Data Link	10-Base Tx 100Mb/s Ethernet to host PC (or any system capable of TCP/IP communication).
System Protection	
Input Voltage	Protection against input voltage transients as per ISO7637 Overload of internal voltage rail will initiate shutdown of both power supplies to prevent overheating. Overload indicated to user by flashing the 'Power IN' LED on front panel.
Power up / down	Protection against unintentional Power down occurrences without damage to transmitter Over-current triggers immediate Tx shutdown. Protection against noise induced timing errors
Internal Wiring	All critical timing wiring connections continually checked for valid connection. Any connection error prevents Tx enabling, or initiates immediate Tx shutdown.
Data Acquisition and Processing	
Sampling Rate	25Hz/50Hz/100Hz/200Hz (software selectable)
Filtering	Selectable low / medium / fast
Noise Cancel	Searches $\pm 3\%$ about the nominal operating frequency for quietest operating point.
Coupling	Selectable AC, DC and Pseudo DC modes for drift compensation.
GPS	Updates the data with the NMEA time stamp every 1 sec (± 0.5 ms) Other times are interpolated based on sampling frequency. Latitude and Longitude can be added to data for reference, updated every 1 sec.
Environmental Standards	
Relative Humidity	Operating: 10% to 90%
Temperature	Operating: -20°C to +45°C
Cables	IP65 (cables exempt when not connected to mating receptacles)

Detection Capabilities	
Detection Speed	Up to 15 km/hr (currently limited by the fastest filter and maximum sample rate) Sampling at 200Hz at 15kph gives a resolution of approx 2.1cm/sec.
Sensor Head Height	50mm minimum ground clearance up to 500mm above surface (if near-surface AT mine threat)

Appendix 5: Ordering Numbers

Description	Minelab Item Number
STMR System, Complete ML Configured	3121-0001
STMR System, Complete ML/F8 Configured	3121-0002
Operation Manual	4901-0049
Control Box, ML Configured	3012-0107
Control Box, ML/F8 Configured	3012-0127
Sun shield set	4101-0012
Mono loop Sensor Head – 2.0m	3120-0005
Mono loop Sensor Head – 3.2m	3120-0004
Rx Paddle containing two coils	2021-0100
Rx 'Y' adapter, Set of 5	0703-0177
Tx Cable, Bundle – for custom sensor heads	9511-0087
Sensor Head, ML/F8 Clutter Rejection	3120-0003
Connector Kit	3004-0031
Plug – Tx Right Angle, Individual	2301-0063
Plug – Power, Individual	2301-0058
Plug – Auxiliary, Individual	2301-0059
Plug – GPS, Individual	2301-0060
Plug – Road Wheel, Individual	2301-0061
Plug – Ethernet, Housing only	2301-0062
PCB – Power Supply	5909-0123
PCB – Transmitter (Tx)	5909-0124
PCB – Recovery	5905-0125
PCB – PS Micro	5909-0126
PCB – Sensor (Rx) for ML configured system	5909-0133
PCB – Sensor (Rx) for ML/F8 configured system	5909-0150
PCB – Controller	5909-0050
PCB – Ethernet Repeater	5909-0135
PCB – Backplane	5909-0134
PCB – Front Panel	5904-0136